

**ARITHMETIC PROGRESSIONS :
COMBINATORIAL AND
NUMBER-THEORETIC PERSPECTIVES**

BY SUJITH VIJAY

**A dissertation submitted to the
Graduate School—New Brunswick
Rutgers, The State University of New Jersey
in partial fulfillment of the requirements
for the degree of
Doctor of Philosophy
Graduate Program in Mathematics**

**Written under the direction of
Professor József Beck
and approved by**

New Brunswick, New Jersey

May, 2007

ABSTRACT OF THE DISSERTATION

Arithmetic Progressions : Combinatorial and Number-theoretic Perspectives

by Sujith Vijay

Dissertation Director: Professor József Beck

A beautiful result in the study of arithmetic progressions modulo 1 is the three distance theorem, conjectured by Steinhaus and proved by Sós, Świerczkowski et al. According to this theorem, there are at most three distinct gaps between consecutive elements in any finite initial segment of the sequence of fractional parts of integer multiples of any real number. We interpret this theorem as a statement about the finiteness of the number of champions in a suitably defined tournament, and obtain higher-dimensional generalizations.

A famous open problem in combinatorial discrepancy theory, raised by Erdős many decades ago, is whether the hypergraph of homogeneous arithmetic progressions has unbounded discrepancy. We investigate a variant of this question. In 1986, Beck showed that given any 2-coloring, the hypergraph of quasi-progressions $\{\lfloor n\alpha \rfloor\}$ corresponding to almost all real numbers α in $[1, \infty)$ has unbounded discrepancy, in fact, at least $\log^* N$, the inverse of the tower function. We make a substantial improvement on this lower bound, replacing $\log^* N$ by $(\log N)^{1/4-o(1)}$, and also show

that there is some quasi-progression with discrepancy at least $(1/50)N^{1/6}$.

A fundamental result in Ramsey theory is the theorem of Hales and Jewett, which states that any 2-coloring of the n^d hypercube admits a monochromatic line for any fixed n and sufficiently large d . We show that the Hales-Jewett number $HJ(n)$ is at least exponential in n , improving the linear lower bound in the original paper of Hales and Jewett.

We also study a game-theoretic variant of the unbounded discrepancy problem where two players, Maker and Breaker, take turns coloring the integers from 0 to N with their own colors. Maker's goal is to obtain a lead on some homogeneous arithmetic progression that exceeds a pre-specified target, and Breaker's goal is to prevent this from happening. We show that given $\varepsilon > 0$, Maker wins if the target is below $N^{1/2-\varepsilon}$ and Breaker wins if the target is above $N^{1/2+\varepsilon}$ for sufficiently large N .

Acknowledgements

I had a wonderful time during my five years here, mostly on account of the company of many nice people. I thank:

- Professor Beck for guidance, support, encouragement, patience and many lessons in conducting research in an enjoyable way.
- Professors Endre Szemerédi, Doron Zeilberger and Vladimir Gurvich for stimulating discussions and valuable suggestions.
- other Rutgers faculty I have interacted with and benefitted from, including Professors Richard Bumby, Stephen Greenfield, Richard Lyons, Stephen Miller, Michael Saks, Simon Thomas, Charles Weibel and Richard Wheeden.
- my past mentors, Dr. Amitabha Tripathi, Professor Wan Fokkink, Dr. Lipika Dey and my high school mathematics teacher Sri P. K. G. Raj.
- my classmates and colleagues – most notably Paul Ellis, Thomas Robinson and Thotsaporn Thanatipanonda, and my past and current housemates – Paritosh Khobare, Ashish Misra and Pradeep George.
- Mrs. Annie Thekkekara, Mrs. Mary Mannamkery, Mrs. Radha Kalyan and their families for hospitality and delicious food.
- my family, friends and all well-wishers.

Dedication

To my parents

Table of Contents

Abstract	ii
Acknowledgements	iv
Dedication	v
1. Overview	1
2. Gaps in Wrapped Progressions	5
3. The Discrepancy of Quasi-progressions	14
4. Variations on Van der Waerden’s Theorem	32
5. The Hales–Jewett Number is Exponential	38
6. Positional Games, Paradoxes and Progressions	45
References	56
Vita	59

Chapter 1

Overview

Introduction

This dissertation investigates questions that arise in number theory, discrepancy theory, Ramsey theory and combinatorial games but run into each other freely. We are primarily interested in the combinatorial properties of set systems consisting of lattice-like objects, such as arithmetic progressions and their generalizations.

Summary of Results

To the relief of experimenters everywhere, rational numbers form a dense subset of the set of real numbers, thus making it is possible to approximate any real number to arbitrary precision using rationals. Given a real number α , the rational numbers arising out of its continued fraction expansion, also known as convergents, turn out to be excellent choices for approximation: their denominators yield smaller fractional parts on multiplication with α than any smaller denominator. This is why convergents are also called best approximations.

What about other approximations, which are not as good? The sequence of fractional parts of positive integer multiples of a real number is called a Kronecker sequence. Notice that the sequence is obtained from an underlying arithmetic progression by reducing the terms modulo 1. If we were to arrange the first n terms of a Kronecker sequence in increasing order, can we discern any patterns? A surprisingly simple answer was conjectured by Steinhaus: there are at most three distinct

gaps between consecutive elements. The conjecture soon became the *three distance theorem*, proved by Sós, Świerczkowski et al. We generalize this theorem to higher dimensions under a suitable formulation.

The three distance theorem can be thought of as a statement about champions in a tournament. The players in the tournament are edges between fractional parts of multiples of the given real number, two edges play each other if and only if they overlap, and an edge loses only against edges of shorter length that it plays against. Defeated edges may play (and defeat) other overlapping edges. According to the three distance theorem, there are at most three distinct values for the lengths of champions, or undefeated edges. Indeed, in the one-dimensional case, champions are precisely the edges joining multiples that are adjacent in the sorted sequence. In the plane and in higher dimensions, we consider fractional parts of multiples of a vector of real numbers, two edges play if their projections along any axis overlap, and champions are defined as before. We show that there are at most 11 distinct values for the lengths of undefeated edges in the plane.

While Kronecker sequences are obtained by taking the *fractional parts* of successive multiples of a real number, Beatty sequences, also known as quasi-progressions, are obtained by taking the *integer parts* instead. They are natural candidates for a subset of positive integers with a given density. An old chestnut tells us that if α and β are irrational numbers whose reciprocals add up to 1, the corresponding quasi-progressions partition the positive integers. Interestingly, a theorem of Uspensky [43] shows that the positive integers cannot be partitioned into three or more quasi-progressions.

A classic theorem of Roth states that if each positive integer less than N is colored red or blue, there exists an arithmetic progression with *discrepancy*, i.e., difference

in the number of reds and blues, at least a power of N , in fact, at least $(1/20)N^{1/4}$. Many years before this theorem, Erdős had asked if the discrepancy of *homogeneous* arithmetic progressions (those that contain 0) is bounded or unbounded. Mathematics appears not yet ready for the original question, so simplifications have to be made. We investigate the quasi-progression analogue of this *unbounded discrepancy problem*.

In 1986, Beck showed that given any 2-coloring of $\{1, 2, \dots, N\}$, the quasi-progressions corresponding to almost all real numbers in $(1, \infty)$ have unbounded discrepancy. However, the lower bound was $\log^* N$, the inverse of the tower function and somewhat on the lethargic side, as far as functions go. In Chapter 3, we improve this bound to the more respectable $(\log N)^{1/4-o(1)}$, and also show that there is some quasi-progression with discrepancy at least $(1/50)N^{1/6}$. The results remain valid even if the 2-coloring is replaced by a partial coloring of positive density, in contrast to homogeneous arithmetic progressions.

If irregularities are of interest in discrepancy theory, regularities are studied in Ramsey theory. The celebrated theorem of Van der Waerden states that any coloring of the integers using finitely many colors admits arbitrarily long arithmetic progressions of one color. Although this theorem was proved eight decades ago, the asymptotic number of monochromatic k -term arithmetic progressions that are inevitable in an r -coloring remains an open problem, even for the simplest case of $r = 2$ and $k = 3$. In Chapter 4, we derive a lower bound for this instance of the problem, using harmonic analysis. Our approach is inspired by the technique used by Roth to establish the lower bound on the discrepancy of arithmetic progressions mentioned earlier. We also note that essentially the same argument can be used to confirm the first of three progressively difficult conjectures of Erdős and Graham on the discrepancy of fixed-length progressions.

A fundamental result in Ramsey theory is the theorem of Hales and Jewett, which states that any 2-coloring of the n^d hypercube admits a monochromatic line for any fixed n and sufficiently large d . In Chapter 5, it is shown that the Hales–Jewett number $HJ(n)$ is at least exponential in n . Previously known lower bounds were not even quadratic in n . This result has interesting ramifications in the theory of positional games (see [7]).

One of the difficulties in analysing a positional game is the so-called extra set paradox. There are instances where the game is a draw on the entire hypergraph, but not on a proper (edge or vertex induced) subgraph. In Chapter 6, a construction that settles the open question about the vertex-induced case for uniform hypergraphs in the affirmative is outlined, and a minimal example of the edge-induced case is given. Such paradoxes cannot occur in Maker-Breaker games, where one player tries to build, and the other tries to block. We investigate the standard and maker-breaker versions of a game motivated by Van der Waerden’s theorem, and a Maker-Breaker variant of the unbounded discrepancy problem of Erdős.

Organization

Chapter 2 deals with the three distance theorem and its higher dimensional generalization. Chapter 3 begins with a general lower bound on the discrepancy of quasi-progressions and goes on to address the more difficult question of “typical behavior”. In Chapter 4, we investigate the discrepancy of arithmetic progressions of fixed length, and obtain a lower bound on the asymptotic minimum number of monochromatic three-term arithmetic progressions in any 2-coloring of the positive integers. Chapter 5 studies the Hales–Jewett number, which is shown to be at least exponentially large. Chapter 6 illustrates the edge and vertex induced versions of the extra set paradox in positional games on uniform hypergraphs and studies games motivated by Van der Waerden’s theorem and the unbounded discrepancy problem.

Chapter 2

Gaps in Wrapped Progressions

Introduction

It is a mundane observation that for any rational number, the sequence of fractional parts of its integer multiples is periodic, and therefore consists of only finitely many distinct elements. Indeed, this property characterizes rational numbers. Kronecker showed, with an easy application of the pigeonhole principle, that for any irrational number α , the sequence $a_k = \{k\alpha\}$ is dense in the unit interval, and also that the analogous result holds in higher dimensions for a vector of irrationals. Bohl, Sierpinski and Weyl, independently of each other, proved in the early 1900s that the sequence is, in fact, uniformly distributed in the unit interval. It is customary to think of such sequences as arising out of rotations on a circle of unit circumference, with the rotation labelled rational or irrational depending on the number being considered. Irrational rotations are of interest in ergodic theory and the study of dynamical systems.

A classic result in the study of irrational rotations is the three distance theorem, proved independently by several authors (see [38] and [40]) in the 1950s in response to a conjecture of Steinhaus. The theorem states that there are at most three distinct gaps between consecutive elements in the set of fractional parts of the first n multiples of any irrational number α . Formally, we have the following:

Theorem A Let α be any irrational number, and n a positive integer. Let

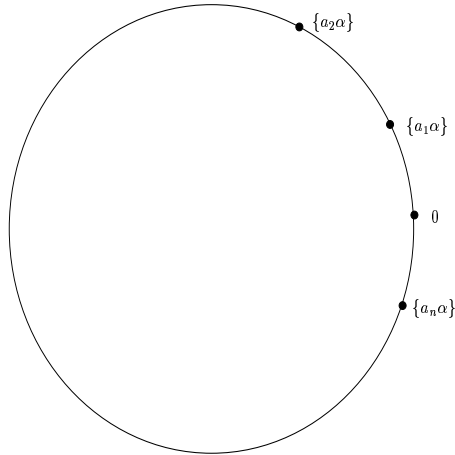

(a_1, a_2, \dots, a_n) be the unique permutation of $\{1, 2, \dots, n\}$ such that

$$0 < \{a_1\alpha\} < \{a_2\alpha\} < \dots < \{a_n\alpha\} < 1$$

Define $g_\alpha(0) = \{a_1\alpha\}$ and $g_\alpha(n) = 1 - \{a_n\alpha\}$. For $1 \leq k \leq n - 1$, let $g_\alpha(k) = \{a_{k+1}\alpha\} - \{a_k\alpha\}$. Define

$$S_\alpha(n) = \{g_\alpha(k) : 0 \leq k \leq n\}$$

Then $|S_\alpha(n)| \leq 3$.

Generalizations

Chung and Graham [12] generalized the three distance theorem as follows:

Theorem B Let $\alpha, \lambda_1, \lambda_2, \dots, \lambda_d$ be real numbers, and let n_1, n_2, \dots, n_d be positive integers. For $1 \leq i \leq d, 1 \leq k \leq n_i$, let $a_{i,k} = \{k\alpha + \lambda_i\}$, where $\{x\}$ denotes the fractional part of x . Then there are at most $3d$ distinct gaps between consecutive $a_{i,k}$.

Geelen and Simpson [20] established the following result, which was generalized by Chevallier [11] to higher dimensions:

Theorem C Let α and β be irrational numbers, and let n_1 and n_2 be positive integers. For $0 \leq k_1 < n_1, 0 \leq k_2 < n_2$, let $a_{k_1, k_2} = \{k_1\alpha + k_2\beta\}$. Then there are at most $n_1 + 3$ distinct gaps between consecutive a_{k_1, k_2} .

Chevallier [10] also obtained the following higher-dimensional analogue of the three-distance theorem for the subsequence of best simultaneous approximation denominators.

Theorem D Let N be a best simultaneous approximation denominator with respect to the Euclidean norm of the d -tuple $(\alpha_1, \alpha_2, \dots, \alpha_d)$. Then there is a norm on R^d such that the Voronoi diagrams of the first N points of the sequence $(\{k\alpha_1\}, \{k\alpha_2\}, \dots, \{k\alpha_d\})$ with respect to this norm are of at most C_d different forms, where C_d is a constant that depends only on the dimension d .

A New Formulation

We show that the central tenet of the three-distance theorem, namely the finiteness of the set of minimal distances, can be generalized to higher dimensions under a suitable interpretation. We begin by rephrasing the theorem in a form that lends itself to the generalization we seek.

We think of the three distance theorem as a statement about champions in a tournament. The players in the tournament are edges connecting $\{j\alpha\}$ and $\{k\alpha\}, 1 \leq j < k \leq n$, two edges play each other if and only if they overlap, and an edge loses only against edges of shorter length that it plays against. Defeated edges are allowed to play (and defeat) other overlapping edges. According to the three distance theorem, there are at most three distinct values for the lengths of undefeated edges. Thus the theorem can be restated as follows:

Theorem A' Let α be any real number, and n a positive integer. Define $d_\alpha(j, k) = ||\{k\alpha\} - \{j\alpha\}||$. Let $I_{j,k}$ be the “geodesic” joining $\{j\alpha\}$ with $\{k\alpha\}$, i.e., if $m_{j,k} = \min(\{j\alpha\}, \{k\alpha\})$ and $M_{j,k} = \max(\{j\alpha\}, \{k\alpha\})$, we define

$$I_{j,k} = \begin{cases} [m_{j,k}, M_{j,k}) & \text{if } M_{j,k} - m_{j,k} \leq 1/2 \\ [0, m_{j,k}) \cup [M_{j,k}, 1) & \text{otherwise} \end{cases}$$

Let $S_\alpha(n) = \{d_\alpha(j, k) : d_\alpha(p, q) < d_\alpha(j, k) \Rightarrow I_{p,q} \cap I_{j,k} = \emptyset\}$. Then $|S_\alpha(n)| \leq 3$.

We first prove a two-dimensional version of this theorem. We show that if the players are edges connecting $(\{j\alpha\}, \{j\beta\})$ and $(\{k\alpha\}, \{k\beta\})$ and two edges play each other if and only if their *projections along either co-ordinate axis* overlap, there are at most 11 distinct values for the lengths of undefeated edges. Numerical evidence suggests that the true value could be as small as 3.

Theorem 1 Let α and β be real numbers, and let n be a positive integer. Define $d_{\alpha,\beta}(j, k) = \sqrt{||{(k-j)\alpha}||^2 + ||{(k-j)\beta}||^2}$. Let $I_{j,k}^1$ and $I_{j,k}^2$ be the geodesics joining $\{j\alpha\}$ with $\{k\alpha\}$ and $\{j\beta\}$ with $\{k\beta\}$ respectively. Define

$$S_{\alpha,\beta}(n) = \{d_{\alpha,\beta}(j, k) : d_{\alpha,\beta}(p, q) < d_{\alpha,\beta}(j, k) \Rightarrow I_{p,q}^1 \cap I_{j,k}^1 = I_{p,q}^2 \cap I_{j,k}^2 = \emptyset\}$$

Then $|S_{\alpha,\beta}(n)| \leq 11$.

Proof We use elementary geometric arguments and the pigeonhole principle. The key idea is that in order to satisfy some packing constraints, most edge-lengths must lose to one or the other of two carefully chosen lengths. The details are as follows:

We begin by classifying the denominators of simultaneous rational approximations to (α, β) . Let $[[x]] = \{x\} - 1/2$. We say that q is a denominator of type $(+, -)$ if $[[q\alpha]] \geq 0$ and $[[q\beta]] < 0$. Denominators of type $(-, +)$, $(+, +)$ and $(-, -)$

are defined analogously. Types $(+, +)$ and $(-, -)$ are said to be opposites to each other, as are types $(+, -)$ and $(-, +)$. We write $q_1 \parallel q_2$ if q_1 and q_2 are of the same type, $q_1 \perp q_2$ if they are of opposite type, and $q_1 \sim q_2$ if they are *not* of opposite type.

We define the *length* and the *angle* of an integer q with respect to α and β as $\ell(q) = d_{\alpha, \beta}(0, q)$, and $\theta(q) = \tan^{-1}([\![q\beta]\!]/[\![q\alpha]\!])$ respectively. Consider the line $L_{a,b}$ joining $(\{a\alpha\}, \{a\beta\})$ and $(\{b\alpha\}, \{b\beta\})$, with $1 \leq a < b \leq n$. Let $q^* = b - a$.

Let Q_1 denote the least integer with the property that $\ell(Q_1) \leq \ell(q)$ for all q , $1 \leq q \leq n/2$. For $n/2 < q \leq n$, we say that q is *primary* if $\ell(q) < \ell(Q_1)$.

Lemma 1.1 If q^* is primary, $\ell(q^*)$ can take at most five distinct values.

Define $Q_1^\perp = \{q : 1 \leq q \leq n - Q_1, q \not\parallel Q_1\}$. Note that Q_1^\perp is non-empty if $Q_1 \geq 2$. Let Q_2 be the least integer in Q_1^\perp such that $\ell(q) \leq \ell(Q_2)$ for all $q \in Q_1^\perp$.

Suppose q^* is not primary. We consider three cases.

CASE 1: $q^* \sim Q_1$

Note that one of $L_{a, a+Q_1}$ or $L_{b-Q_1, b}$ will be admissible, and will defeat $L_{a,b}$.

CASE 2: $q^* \perp Q_1$ and $1 \leq q^* \leq n - Q_1$

Clearly, $\ell(q^*) \geq \ell(Q_2)$. Moreover, if equality does not hold, one of $L_{a, a+Q_2}$ or $L_{a-Q_1, a}$ will defeat $L_{a,b}$.

CASE 3: $q^* \perp Q_1$ and $n - Q_1 < q^* \leq n$

Note that if $Q_1 = 1, q^* = n$. Otherwise, Q_2 exists, and we say that q^* is *secondary* if $\ell(q^*) < \ell(Q_2)$. Observe that if q^* is not secondary, one of $L_{a,a+Q_2}$ or $L_{a-Q_1,a}$ will defeat $L_{a,b}$.

Lemma 1.2 If q^* is secondary, $\ell(q^*)$ can take at most four distinct values.

Assuming Lemmas 1.1 and 1.2, it follows that at most eleven distinct gaps survive. It remains to prove the two lemmas.

Proof of Lemma 1.1 Consider four quarter-circles of radius $R = \ell(Q_1)$ centred at the four corners of the unit square. Suppose there exist $q_i, 1 \leq i \leq 7$ with $n/2 < q_1 < q_2 < \dots < q_7 \leq n$ and $\ell(q_i) < R$. Then there must be a pair $(i, j), 1 \leq i < j \leq 7$ such that $\theta \doteq |\theta(q_j) - \theta(q_i)| < \pi/3$. But then we have $\ell(q_j - q_i) < R$, yielding a contradiction, since $1 \leq q_j - q_i < n/2$.

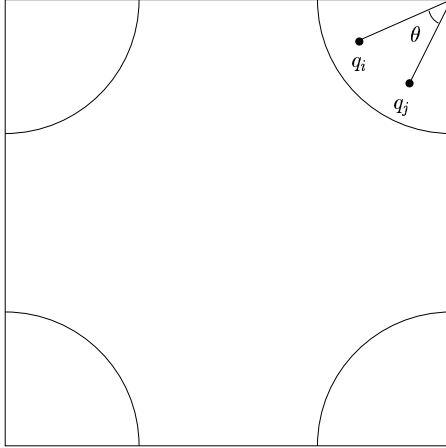

Furthermore, the only way to have six primary q_i avoiding $\ell(q_j - q_i) < R$ is to arrange them along the vertices of a regular hexagon, leading to identical values of $\ell(q_i)$. It follows that $\ell(q^*)$ can take at most five distinct values if q^* is primary. ■

Proof of Lemma 1.2 We claim that there does not exist $q < Q_1$ satisfying $\|q\alpha\| < (\ell(Q_2)/2)$ and $\|q\beta\| < (\ell(Q_2)/2)$. Suppose there is such a q . Observe that $\ell(Q_1 - q) \leq \ell(Q_2)$ and $Q_1 - q \not\parallel Q_1$. This contradicts the definition of Q_2 .

Now suppose that $n - Q_1 < q_1 < q_2 < \dots < q_5 < n$, with $\ell(q_i) < \ell(Q_2)$ and $q_i \perp Q_1$. Since $q_1 \parallel q_2 \parallel \dots \parallel q_5$, it is easy to see that there exist i and j satisfying $\|(q_i - q_j)\alpha\| < \ell(Q_2)/2$, $\|(q_i - q_j)\beta\| < \ell(Q_2)/2$ and $q_i - q_j < Q_1$, contradicting our claim above, and proving the lemma. \blacksquare

Higher Dimensions

For higher dimensions, the above argument can be adapted to obtain similar results. We prove the following theorem which implies, in particular, that there are at most 74 distances in three dimensions.

Theorem 2 Let $\alpha \doteq (\alpha_1, \alpha_2, \dots, \alpha_m) \in \mathbf{R}^m$, and let n be a positive integer.

Define

$$d_\alpha(j, k) = \sqrt{\sum_{i=1}^n \|(k - j)\alpha_i\|^2}$$

For $1 \leq r \leq m$, let $I_{j,k}^r$ denote the geodesic joining $\{j\alpha_r\}$ with $\{k\alpha_r\}$. Define

$$S_\alpha(n) = \{d_\alpha(j, k) : d_\alpha(p, q) < d_\alpha(j, k) \Rightarrow I_{p,q}^r \cap I_{j,k}^r = \emptyset \text{ for all } r.\}$$

Then

$$|S_\alpha(n)| \leq (2^m + 1)(\lceil \sqrt{m} \rceil^m) + 2$$

Proof Let $\lceil \lceil x \rceil \rceil = \{x\} - 1/2$. As in the proof of Theorem 1, we assign, to each denominator q an m -tuple of signs. The i^{th} sign is positive if $\lceil \lceil q\alpha_i \rceil \rceil \geq 0$ and negative otherwise.

The *length* of an integer q with respect to α is defined as $\ell(q) = d_\alpha(0, q)$. Let Q_1 denote the least integer with the property that $\ell(Q_1) \leq \ell(q)$ for all q , $1 \leq q \leq n/2$. For $n/2 < q \leq n$, we say that q is *primary* if $\ell(q) < \ell(Q_1)$.

Lemma 2.1 There are at most $(2\lceil\sqrt{m}\rceil)^m$ primary denominators in \mathbf{R}^m for any given α .

As in the planar case, define $Q_1^\perp = \{q : 1 \leq q \leq n - Q_1, q \nparallel Q_1\}$, and let Q_2 be the least integer in Q_1^\perp such that $\ell(q) \leq \ell(Q_2)$ for all $q \in Q_1^\perp$. Note that Q_1^\perp is non-empty if $Q_1 \geq 2$.

Consider the line $L_{a,b}$ joining $(\{a\alpha\}, \{a\beta\})$ and $(\{b\alpha\}, \{b\beta\})$, with $1 \leq a < b \leq n$. Let $q^* = b - a$. Suppose q^* is not primary. We consider two cases.

CASE 1: $q^* \sim Q_1$

Note that one of $L_{a,a+Q_1}$ or $L_{b-Q_1,b}$ will be admissible, and will defeat $L_{a,b}$.

CASE 2: $q^* \perp Q_1$ and $1 \leq q^* \leq n - Q_1$

As before, $\ell(q^*) \geq \ell(Q_2)$ and if equality does not hold, one of $L_{a,a+Q_2}$ or $L_{a-Q_1,a}$ will defeat $L_{a,b}$.

CASE 3: $q^* \perp Q_1$ and $n - Q_1 < q^* \leq n$

Note that if $Q_1 = 1$, $q^* = n$. Otherwise, Q_2 exists, and we say that q^* is *secondary* if $\ell(q^*) < \ell(Q_2)$. If q^* is not secondary, one of $L_{a,a+Q_2}$ or $L_{a-Q_1,a}$ will be admissible, and will defeat $L_{a,b}$.

Lemma 2.2 If q^* is secondary, $\ell(q^*)$ can take at most $(\lceil\sqrt{m}\rceil^m + 1)$ distinct values.

Note that the statement of the theorem is a direct consequence of Lemmas 2.1 and 2.2. We now prove these lemmas.

Proof of Lemma 2.1 If the number of distinct values q satisfying $\ell(q) < \ell(Q_1)$ exceeds $(2\lceil\sqrt{m}\rceil)^m$, at least $1 + \lceil\sqrt{m}\rceil^m$ of these values must be of the same type. By pigeonhole principle, there exists q_1 and q_2 with $\|(q_2 - q_1)\alpha_i\| < \ell(Q_1)/\sqrt{m}$ for all $i, 1 \leq i \leq m$. It follows that $\ell(q_2 - q_1) < \ell(Q_1)$. But $q_2 - q_1 < n/2$, contradicting the definition of Q_1 . Thus at most $(2\lceil\sqrt{m}\rceil)^m$ denominators can be primary. ■

Proof of Lemma 2.2 We claim that there does not exist $q < Q_1$ satisfying $\|Q\alpha_i\| < \ell(Q_2)/\sqrt{m}$. Suppose there exists such a q . Note that $\ell(Q_1 - q) < \ell(Q_2)$ and $Q_1 - q \not\ll Q_1$, contradicting the definition of Q_2 .

Now suppose that for $k = (\lceil\sqrt{m}\rceil^m + 1)$, we have

$$n - Q_1 < q_1 < q_2 < \cdots < q_k < n$$

with $\ell(q_i) < \ell(Q_2)$. Since $q_1 \| q_2 \| \cdots \| q_k$, there exist i and j with

$$\|(q_i - q_j)\alpha_r\| < \ell(Q_2)/\sqrt{m}, 1 \leq r \leq m$$

and $q_i - q_j < Q_1$, contradicting our claim above, and proving the lemma. ■

Chapter 3

The Discrepancy of Quasi-progressions

Introduction

Combinatorial discrepancy theory concerns itself with balanced colorings of hypergraphs. The objective is to partition the vertex set in such a way that all hyperedges are split as evenly as possible. This is a noble and worthy plan, but often unrealistically optimistic. A case in point is the classic theorem of Roth [35] stating that if the elements of $\{0, 1, 2, \dots, n\}$ are 2-colored, there exists an arithmetic progression $\{a, a + d, \dots, a + (k - 1)d\}$ of discrepancy at least $(1/20)n^{1/4}$, with $0 \leq a < d \leq \sqrt{6n}$. Roth conjectured that the exponent can be improved from $1/4$ to $1/2$, but this was disproved by Sárközy (see [15]), who established an upper bound of $O(n^{1/3+\varepsilon})$ for arbitrarily small ε . In 1981, Beck improved the upper bound to $O(n^{1/4}(\ln n)^{5/2})$, showing that Roth's estimate was essentially sharp. Finally, in 1996, Matoušek and Spencer [29] showed that Roth's original estimate was sharp up to constants, thereby putting the problem to rest.

The situation is quite different, however, for *homogeneous* arithmetic progressions (HAPs), the subfamily of arithmetic progressions containing 0. It turns out that there are extremely well-balanced colorings for such arithmetic progressions. Consider the family of completely multiplicative *partial* colorings χ_p^* defined for each odd prime p via the Legendre symbol.

- $\chi_p^*(a) = 1$ if $(a, p) = 1$ and a is a quadratic residue modulo p
- $\chi_p^*(a) = -1$ if $(a, p) = 1$ and a is a quadratic non-residue modulo p

- $\chi_p^*(a) = 0$ if a is a multiple of p .

For example,

$$\chi_3^*(3k+1) = 1; \chi_3^*(3k+2) = -1; \chi_3^*(3k) = 0$$

Clearly, all HAPs contained in $\{0, 1, \dots, n\}$ have discrepancy at most 1 under χ_3^* . In general, the discrepancy of all HAPs are bounded by $(p-1)/2$ under χ_p^* . Also note that χ_p^* is “almost admissible” for large p , since only a small fraction of numbers is colored 0. In fact, it is possible to turn these partial colorings into completely admissible colorings, as illustrated below for $p = 3$:

$$\chi_3(3k+1) = 1; \chi_3(3k+2) = -1; \chi_3(3k) = \chi_3(k)$$

It is easy to show that all HAPs have discrepancy $O(\log n)$ under χ_3 . Whether there is a “fully admissible” coloring of bounded discrepancy for HAPs is a question raised by Erdős in the 1930s, (see [18]) and one that remains unsolved to this day, in spite of a relatively high bounty of \$500. It is indeed a mishap that this innocent-looking question should turn out to be so difficult.

Yet homogeneous arithmetic progressions are tiny herrings on the tip of the iceberg of quasi-progressions. Perhaps a definition is in order. A quasi-progression $Q(\alpha; s, t)$ is the sequence of integers

$$\lfloor s\alpha \rfloor, \lfloor (s+1)\alpha \rfloor, \dots, \lfloor t\alpha \rfloor$$

In other words, a quasi-progression is a sequence of successive multiples of a real number, with each multiple rounded down to the nearest integer. To avoid repetition of elements, it is natural to assume $\alpha \geq 1$. Since distinct real numbers yield distinct quasi-progressions, we are dealing with an uncountable family of sequences. Note that for integer values of α , quasi-progressions reduce to HAPs, or the set-difference of two HAPs. Thus the problem raised by Erdős concerns a subfamily of quasi-progressions, corresponding to integer values of α .

A Global Lower Bound

We first establish a lower bound on the discrepancy of the family of all quasi-progressions contained in $\{0, 1, \dots, n\}$.

Theorem 3 If the integers from 0 to n are 2-colored, there exists $\alpha > 1$ and integers s and t such that the quasi-progression $Q(\alpha; s, t)$ has discrepancy at least $(1/50)n^{1/6}$.

Proof Let $m < n$. The value of m will be specified at the end of the proof. By Roth's theorem, there exists an arithmetic progression $P_1 = \{a, a + d, a + 2d, \dots\}$ contained in $\{0, 1, \dots, m\}$, $2 \leq d < \sqrt{6m}$, $0 \leq a < d$, with discrepancy at least $(1/40)m^{1/4}$. Let $P_2 = (n - m) + P_1$. We will show that for suitably chosen m , P_2 can be realized as a quasi-progression corresponding to a real number $\alpha > 1$.

Observe that if $\alpha = d - \varepsilon$, the first $\lfloor 1/\varepsilon \rfloor$ elements in the sequence $\lfloor \alpha \rfloor, \lfloor 2\alpha \rfloor, \lfloor 3\alpha \rfloor, \dots$ are congruent to $-1 \pmod{d}$, the next $(\lfloor 2/\varepsilon \rfloor - \lfloor 1/\varepsilon \rfloor)$ elements are congruent to $-2 \pmod{d}$, and so on. In particular, the arithmetic progression $P_2 \equiv -(d - a) \pmod{d}$ can be realized as a quasi-progression by choosing ε such that P_2 is completely contained in the $(d - a)^{\text{th}}$ block of length $(1/\varepsilon) + O(1)$.

Since $P_2 \subseteq \{n - m, n - m + 1, \dots, n\}$, it suffices to choose ε such that $(d - a - 1)\lfloor 1/\varepsilon \rfloor < n - m$ and $(d - a)\lfloor 1/\varepsilon \rfloor > n$. Such an ε exists if

$$\frac{n - m}{d - a - 1} - \frac{n}{d - a} > 1$$

Note that $d - a \leq d \leq \sqrt{6m}$. Therefore, we can choose $m = \lfloor 6^{-1/3}n^{2/3} \rfloor$. This yields a quasi-progression of discrepancy at least $(1/50)n^{1/6}$. ■

Typical Behavior

While it is not known whether the set of homogeneous arithmetic progressions have bounded discrepancy, there exist colorings (see [32]) for which the arithmetic progression $\{0, d, 2d, \dots\}$ has discrepancy at most $d^{4+o(1)}$ for all d . It turns out, however, that upper bounds independent of n do not exist for most quasi-progressions.

Let $\alpha > 1$ be given, together with a 2-coloring of $\{0, 1, \dots, n\}$. Let $D_\alpha(n)$ denote the maximum discrepancy of $Q(\alpha; s, t)$ over all admissible s and t . In 1986, Beck [5] showed that given any 2-coloring of the non-negative integers, for almost every $\alpha \in [1, \infty)$, there are infinitely many n such that $D_\alpha(n) \geq \log^* n$. Recall that $\log^* x$ denotes the inverse of the tower function: $\log^* x = \ln x$ for $1 < x < e$ and $\log^*(e^x) = 1 + \log^* x$.

We improve on this result, and prove the following $(\log n)$ -power bound.

Theorem 4 Let χ be a partial coloring of the non-negative integers with density $\rho > 0$, and let χ_n denote the restriction of χ to $\{0, 1, \dots, n\}$. Then for almost every $\alpha \in [1, \infty)$, there are infinitely many n such that $D_\alpha(n) \geq (\log n)^{1/4-o(1)}$.

Proof Let E denote the set of α such that there are only finitely many n with $D_n(\alpha) \leq (\log n)^{1/4-o(1)}$ under the coloring χ . If E has positive measure, there exists a positive integer t for which the set of balanced α in $[t, t+1)$ has measure $\delta > 0$. But it follows from the Main Lemma (see below) that there exists $c_0 = c_0(\rho, t, \delta)$ such that the set of α with $D_n(\alpha) \leq c_0(\log n)^{1/4}$ has measure less than δ . For all other α in $[t, t+1)$, we have $D_n(\alpha) > (\log n)^{1/4-o(1)}$ for sufficiently large n , yielding a contradiction. ■

It remains to state and prove the Main Lemma.

Main Lemma Let χ and χ_n be as in the statement of Theorem 4. Given $t \in [1, \infty)$ and $\delta > 0$, there exists $c_0 = c_0(\rho, t, \delta)$ such that the set of α in $[t, t + 1)$ with $D_\alpha(n) \leq c_0(\log n)^{1/4}$ under χ_n has Lebesgue measure less than δ .

Remark: We say that α is M -balanced if $D_\alpha(n) \leq M$. For brevity, we shall hereafter refer to $(c_0(\log n)^{1/4})$ -balanced α simply as “balanced”. We will transform the problem into a geometric setting, with a view to using orthogonal functions and Bessel’s inequality, as was done by Roth [34] in his classic paper on the measure-theoretic discrepancy of axis-parallel rectangles. A similar construction was used by Hochberg (see [25] and [26]) to show the existence of a quasi-progression of discrepancy $c'_0(\log n)^{1/4}$. As we saw in Theorem 3, quasi-progressions with much larger discrepancy do occur.

Proof We shall assume, for the sake of convenience, that $n = (t + 1)m$ where $m = 2^u$ for some positive integer u . We join each lattice point (a, b) with the one vertically above it, and give the resulting unit segment the color $\chi(b)$. For each point (x, y) in the plane, the discrepancy function $D(x, y)$ is defined to be the sum of the χ -values of the unit segments crossed by the line joining $(0, 0)$ and (x, y) . Note that $|D(x, y)| \leq M$ if and only if y/x is M -balanced.

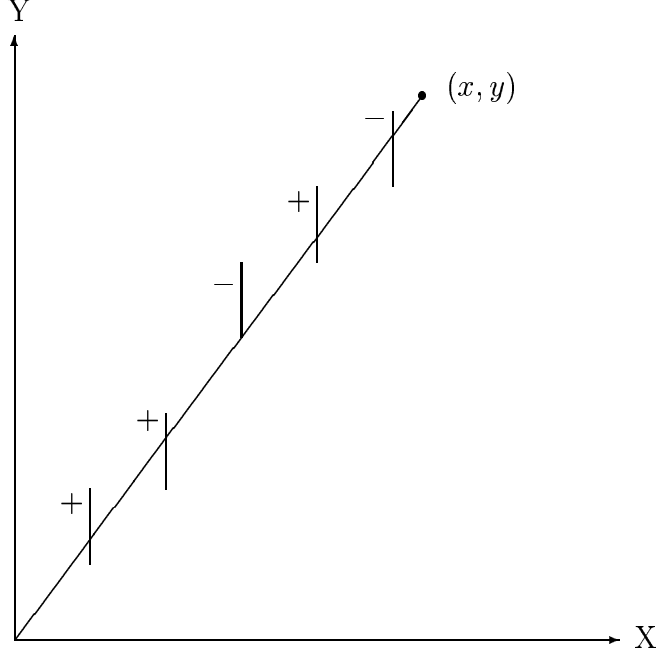

Let $H(x, y) = D(x, y)$ if y/x is balanced, and 0 otherwise. Suppose that the measure of the set of balanced α in $[t, t + 1)$ is at least δ . We will deduce a contradiction for a suitably chosen c_0 by producing a point (x_0, y_0) with $H(x_0, y_0) > c_0(\log n)^{1/4}$.

Let R denote the region bounded by the lines $x = m/2, x = m, y = tx, y = (t + 1)x$. We will construct orthonormal functions g_1, g_2, \dots, g_r on R where $r = (\log n)/8$ and

$$\sum_{i=1}^r (\langle H, g_i \rangle)^2 \geq \frac{\rho^2 \delta^{13} m^2 (\log n)^{1/2}}{2^{29} c_0^2 t^3}$$

Since R has area $3m^2/8$, it follows from Bessel's inequality that there exists (x_0, y_0) with $H(x_0, y_0) > c_0(\log n)^{1/4}$ for

$$c_0(\rho, t, \delta) = \frac{\rho^{1/2} \delta^{13/4}}{120 t^{3/4}}$$

yielding the desired contradiction.

The functions g_1, g_2, \dots, g_r will be normalized versions of mutually orthogonal functions G_1, G_2, \dots, G_r . Following Hochberg, we will construct G_i by dividing R

into a grid of trapezoids, called the i^{th} trapezoidal grid. We use vertical lines spaced $\ell = 2^i$ apart and slanting lines with slopes equally spaced between t and $t + 1$. The slopes of consecutive slanting lines differ by $\tau \doteq 1/(\ell\beta m)$ where $\beta = c_2(\log n)^{1/4}$. The value of c_2 will be specified later. It is easy to see that the individual grid trapezoids have area at most $1/\beta$ and at least $1/(2\beta)$.

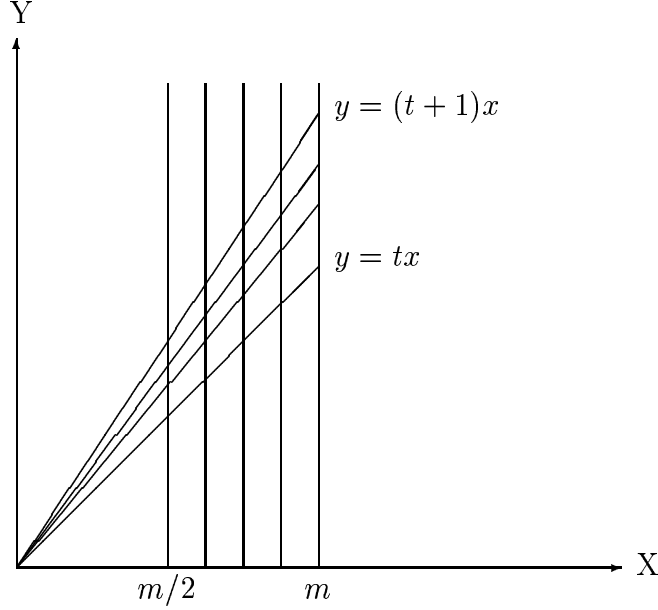

Note that we have specified only the spacing between the grid lines and not their actual position. We choose the position of the rightmost vertical line randomly and uniformly in the interval $[n - \ell, n)$, and the slope of the lowermost line randomly and uniformly in the interval $[t, t + \tau)$. The region between two consecutive sloping lines will be called a *sector*, and sectors will be identified with subintervals of $[t, t + 1)$ in the natural fashion. We will denote the measure of balanced α in the j^{th} sector of the i^{th} grid by μ_{ij} . For convenience, we define $\mu_{ij}^* = \mu_{ij}/\tau$.

If $\chi(b) \neq \chi(b - 1)$, we refer to b as a *switch value*. Furthermore, a lattice point (a, b) will be called a *switch point* if b is a switch value. A switch point is said to be *good* if it finds itself alone in a trapezoid no matter how the grid is positioned; *bad* otherwise. We shall denote the number of good switch points in the j^{th} sector of the i^{th} grid by s_{ij}^* .

We define G_i as follows: On a trapezoid containing exactly one good switch point, G_i is defined in a chessboard fashion. On all other trapezoids, G_i is defined to be identically zero.

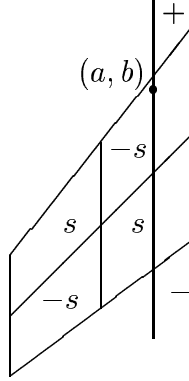

The vertical dividing line passes through the centre of the trapezoid. The position of the slanting dividing line is chosen such that the measure of balanced α above the line and inside the sector equals the measure of balanced α below the line and inside the sector. The value of s will vary from trapezoid to trapezoid, but will always equal $+1$ or -1 . Since the vertical dividing lines are nested dyadically (note that the vertical spacing is $\ell = 2^i$), it is clear that $\{G_i\}$ form an orthogonal family.

We now derive a lower bound on the inner product $\langle H, G_i \rangle$. The position of the slanting dividing line has been chosen with a view to extending Hochberg's argument for the $\mu_{ij}^* = 1$ case to the more general problem at hand.

Lemma 4.1 $E(\langle H, G_i \rangle) \geq (\sum_j (\mu_{ij}^*)^2 s_{ij}^*) / (64\beta)$

Proof Consider the contribution of a unit vertical segment $\ell_{a,b}$ joining (a, b) and $(a, b+1)$ to the discrepancy function $H(x, y)$. Let

$$B_{a,b} = \left\{ (x, y) : x \geq a, \frac{b}{a} \leq \frac{y}{x} < \frac{b+1}{a} \right\}$$

denote the set of points behind the line $\ell_{a,b}$.

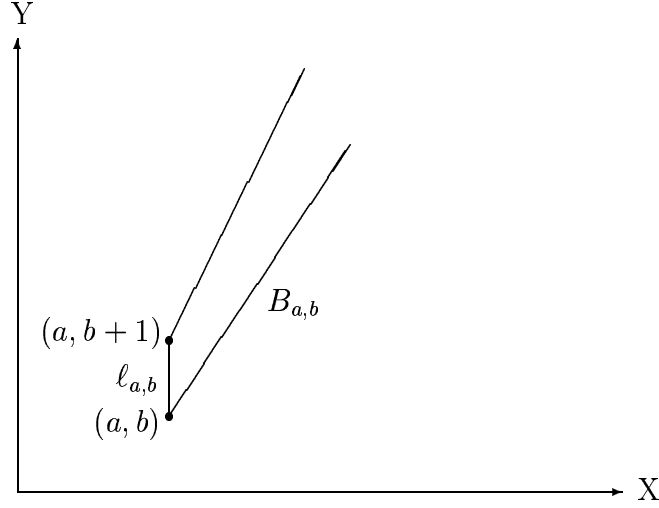

Now define

$$H_{a,b}(x, y) = \begin{cases} \chi(b) & \text{if } (x, y) \in B_{a,b} \text{ and } y/x \text{ is balanced} \\ 0 & \text{otherwise} \end{cases}$$

Clearly,

$$H(x, y) = \sum_{a=0}^{\infty} \sum_{b=0}^{\infty} H_{a,b}(x, y)$$

Furthermore, only finitely many terms in this sum are non-zero, for any fixed (x, y) . Consider a good switch point (a, b) lying inside a trapezoid T , located in the j^{th} sector of the i^{th} grid.

We claim that if neither (a, b) nor $(a, b + 1)$ lie inside T , then

$$\int_T \int G_i(x, y) H_{a,b}(x, y) dx dy = 0$$

If T lies entirely outside or entirely inside $B_{a,b}$, it is clear that the integral is zero. If exactly one of the bounding lines of $B_{a,b}$ intersects T , the geometric symmetry with respect to the vertical dividing line or the measure-theoretic symmetry with respect to the sloping dividing line, as the case may be, ensures that there is perfect

cancellation. Thus the integral vanishes in this case as well.

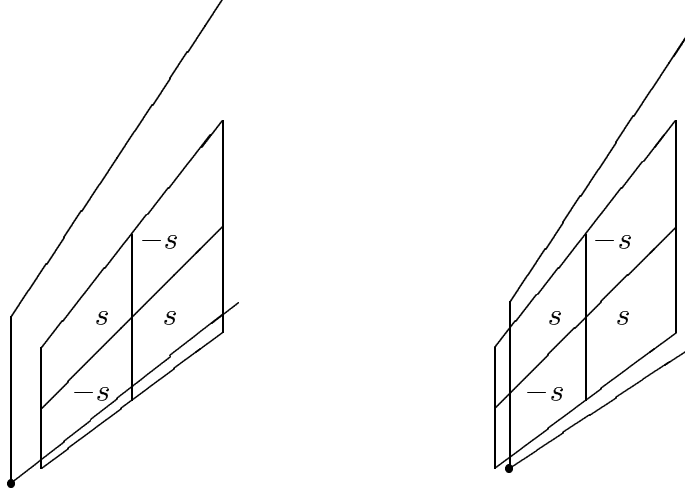

Therefore, we need consider only the terms $H_{a,b}(x, y)$ and $H_{a,b-1}(x, y)$, where $(a, b) \in T$. If (a, b) is not a switch point, we have,

$$\int_T \int G_i(x, y)(H_{a,b}(x, y) + H_{a,b-1}(x, y)) dx dy = 0$$

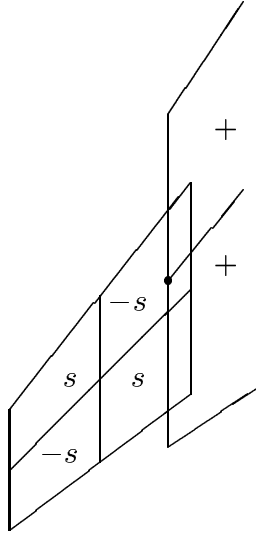

Now suppose that (a, b) is a switch point. If (a, b) lies on the intersection of the two dividing lines, we have

$$\int_T \int G_i(x, y)(H_{a,b}(x, y) + H_{a,b-1}(x, y)) dx dy = \frac{s}{4}(\chi(b) - \chi(b - 1))\mu_{ij}^* \text{ area}(T)$$

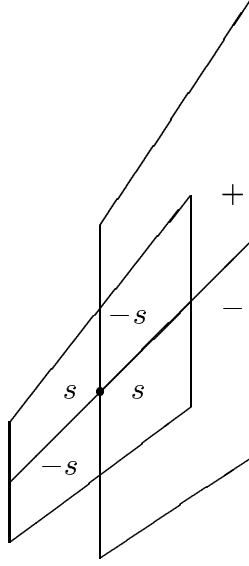

We choose s so that the integral is positive. Since the switch point p is good, there are no other lattice points in T , and the value of s can now be safely assumed fixed. Thus we get

$$\int_T \int G_i(x, y) H(x, y) dx dy \geq \frac{\mu_{ij}^*}{8\beta}$$

provided (a, b) lies on the intersection of the two dividing lines. The location of (a, b) inside the trapezoid is a uniformly distributed random variable. For the purposes of computing the expectation, we can assume that T is a parallelogram, at the expense of a multiplicative constant. Thus we have

$$E \left(\int_T \int G_i(x, y) H(x, y) dx dy \right) \geq \frac{(\mu_{ij}^*)^2}{64\beta}$$

Adding over all switch points and using the linearity of expectation, we get

$$E(\langle H, G_i \rangle) \geq \frac{1}{64\beta} \sum_j (\mu_{ij}^*)^2 s_{ij}^*$$

as claimed. ■

We now prove a slightly stronger version of a lemma due to Beck [5].

Lemma 4.2 Let $J \subseteq [0, 1]$ be an arbitrary interval of length λ and let $1 \leq b_1 < b_2 < \dots < b_q$ be integers. Let $N(\alpha, J) = |\{j : \{b_j \alpha\} \in J, 1 \leq j \leq q\}|$.

If $q \geq \lambda^{-6}$, then $\mu(\{\alpha \in [0, 1] : N(\alpha, J) \geq (q\lambda/2)\}) \geq 1 - (8/\sqrt{q})$.

Proof The proof uses LeVeque's inequality from the theory of uniform distributions (see [27]), and is almost identical to the proof of Beck's original lemma.

Let $x_j = \{b_j\alpha\}$, $1 \leq j \leq q$. Define $\Delta(\alpha)$ and $S_n(\alpha)$ as follows:

$$\Delta(\alpha) = \sup_{0 \leq a < b \leq 1} \left| \left(\sum_{j: x_j \in [a, b)} \frac{1}{q} \right) - (b - a) \right|$$

$$S_n(\alpha) = \frac{1}{q} \sum_{j=1}^q e^{2\pi i n x_j}$$

Note that

$$\int_0^1 |S_n(\alpha)|^2 d\alpha = \frac{1}{q^2} \int_0^1 \sum_{j=1}^q \sum_{k=1}^q e^{2\pi i n (b_j - b_k)\alpha} d\alpha = \frac{1}{q}$$

By LeVeque's inequality,

$$\Delta^3(\alpha) \leq \frac{6}{\pi^2} \sum_{n \in \mathbf{N}} \frac{|S_n(\alpha)|^2}{n^2}$$

Therefore,

$$\int_0^1 \Delta^3(\alpha) d\alpha \leq \frac{6}{\pi^2} \int_0^1 \left(\sum_{n \in \mathbf{N}} \frac{1}{n^2} |S_n(\alpha)|^2 \right) d\alpha = \frac{1}{q}$$

Let $E = \{\alpha \in [0, 1) : N(\alpha, J) \geq q\lambda/2\}$ and $F = [0, 1) \setminus E$. Clearly,

$$\frac{\lambda^3 \mu(F)}{8} \leq \int_0^1 \left| \left(\sum_{j: x_j \in J} \frac{1}{q} \right) - \lambda \right| d\alpha \leq \int_0^1 \Delta^3(\alpha) d\alpha$$

Therefore, $\lambda^3 \mu(F)/8 \leq 1/q$. Since $q \geq \lambda^{-6}$, we have

$$\mu(E) = 1 - \mu(F) \geq 1 - \frac{8}{\sqrt{q}},$$

proving the lemma. \blacksquare

Let b_1, b_2, \dots, b_q be the switch values of the coloring χ in $[N/2, N]$. Note that $q \geq (N\rho)/(4c_0(t+1)(\log n)^{1/4}) = (m\rho)/(4c_0(\log n)^{1/4})$. Since switch points come in rows, it is clear that χ_n gives rise to mq switch points.

Lemma 4.3 $\sum_j (\mu_{ij}^*)^2 s_{ij}^* \geq \delta^5 mq / (4096t)$, for $1 \leq i \leq r$

Proof We say that a sector is *rich* if $\mu_{ij}^* > \delta/2$. Let $\{I_k\}_{k=1}^L$ be an enumeration of the rich sectors. Since $(\delta/2)(n\ell\beta - L) + L\tau \geq \delta$, we have $L > (\delta/2)m\ell\beta$.

We use Lemma 2 with $J = [0, \delta/(4\ell\beta(t+1))]$, so that $\lambda = \delta/(4\ell\beta(t+1))$. Since $r = \log m/8$ and $i \leq r$, we have $q \geq \lambda^{-6}$. For an arbitrary interval $I = [a_k, b_k)$, let I' and I'' denote $[a_k, c_k)$ and $[c_k, b_k)$ respectively, where the measure of balanced α in I' and I'' are equal. Let $A = \cup_{k=1}^L I'_k$. Note that A has measure at least $\delta^2/8$. Let $B = \{\theta : 1/\theta \in A\}$. Since $A \subseteq [t, t+1) \subseteq [t, 2t)$, the measure of B is at least $\delta^2/(32t^2)$.

Let $B^* = \{\theta \in B : N(\theta, J) \geq (q\lambda)/2\}$. For sufficiently large n , B^* has measure at least $\delta^2/(64t^2)$. Note that $\theta \in B^* \Rightarrow 1/\theta \in I'_k$ for some k . Suppose $\{b_v\theta\} \in J$ for such a θ . Let $a_v = \lfloor b_v\theta \rfloor$. Then we have,

$$0 < \frac{b_v}{a_v} - \frac{1}{\theta} < \frac{2\lambda(t+1)}{m} < \frac{\delta\tau}{4}$$

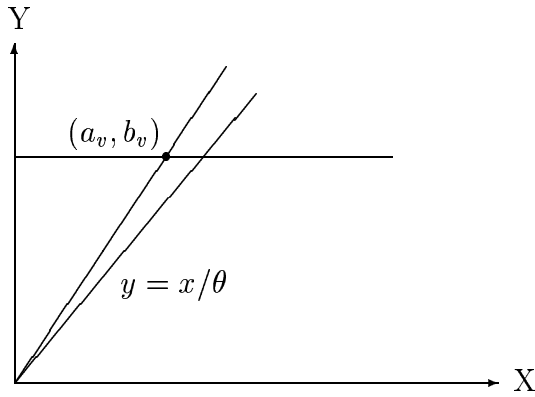

It follows that $(b_v/a_v) \in I_k$. Thus the k^{th} sector contains a switch point of the form (a_v, b_v) .

Since the contribution of a single I'_k towards the measure of B^* is at most τ/t^2 , there must be at least $\delta^2 m \ell \beta / (32t^2)$ rich sectors contributing at least $\delta^3 m q / (1024t)$ switch points between them.

We now derive an upper bound on the total number of bad switch points.

Given a bad switch point (a, b) , there exists a' such that

$$|a' - a| \leq \ell \text{ and } \left\| \frac{ba'}{a} \right\| < \frac{1}{\ell\beta}$$

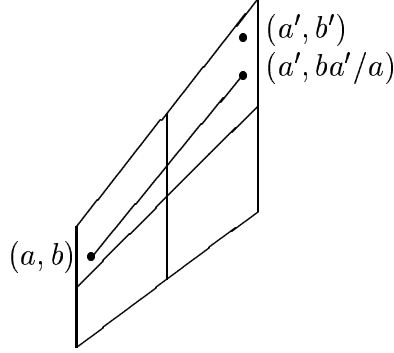

Let $d = |a' - a|$. Note that there are $m\ell/2$ pairs (a, d) with $1 \leq d \leq \ell$, $m/2 \leq a \leq m$. For each such pair, there are $a/(\ell\beta) + O(\ell)$ values of b that satisfy $\|bd/a\| < 1/(\ell\beta)$. It follows that there are at most m^2/β lattice points which do not find themselves alone in a trapezoid for some placement of the grid.

Since the number of bad switch points is at most

$$\frac{m^2}{\beta} = \frac{m^2}{c_2(\log n)^{1/4}} < \frac{\delta^3 m q}{1024t}$$

for $c_2 \geq 4096c_0t/(\delta^3\rho)$, we have

$$\sum (\mu_{ij}^*)^2 s_{ij}^* > \frac{\delta^5 m q}{4096t}$$

as required. \blacksquare

Note that

$$E(\langle H, G_i \rangle^2) \geq [E(\langle H, G_i \rangle)]^2 \geq \left(\sum_j \frac{(\mu_{ij}^*)^2 s_{ij}^*}{64\beta} \right)^2$$

Furthermore, the combined area of all the grid trapezoids containing exactly one switch point is at most mq/β . Therefore,

$$E(\langle H, g_i \rangle^2) \geq \frac{(\sum_j (\mu_{ij}^*)^2 s_{ij}^*)^2}{4096mq\beta} \geq \frac{\rho^2 \delta^{13} m^2}{2^{26} c_0^2 t^3 (\log n)^{1/2}}$$

By the linearity of expectation,

$$E \left(\sum_{i=1}^r \langle H, g_i \rangle^2 \right) \geq \frac{\rho^2 \delta^{13} m^2 (\log n)^{1/2}}{2^{29} c_0^2 t^3}$$

Thus, for some placement of the grids, the resulting g_i satisfy

$$\sum_{i=1}^r (\langle H, g_i \rangle)^2 \geq \frac{\rho^2 \delta^{13} m^2 (\log n)^{1/2}}{2^{29} c_0^2 t^3}$$

yielding the statement of the main lemma. \blacksquare

Upper Bounds

We derive an upper bound of $O(N^{1/3+\varepsilon})$ on the discrepancy of quasi-progressions contained in $\{0, 1, 2, \dots, N\}$. We begin with an easier estimate. We will show that there are $\Theta(N^2)$ distinct maximal quasi-progressions contained in $\{1, 2, \dots, N\}$. This will yield an upper bound of $O(\sqrt{N \log N})$ on the discrepancy of quasi-progressions via a standard random coloring argument (see [1]).

Let $F_N \doteq \{a/b : 0 \leq a \leq b \leq N; (a, b) = 1\}$ denote the Farey sequence of order N . It is well-known (see [24]) that $|F_N| \sim \frac{3N^2}{\pi^2}$.

Let $\overline{F}_N \doteq \{1/x : x \in F_N, x \neq 0\}$. Observe that distinct elements of \overline{F}_N give rise to quasi-progressions whose restrictions to $\{1, 2, \dots, N\}$ are distinct. Let $\overline{F}_N[i]$ denote the i^{th} smallest element of \overline{F}_N . Given $\alpha \in (1, N]$, we have $\overline{F}_N[t] \leq \alpha < \overline{F}_N[t+1]$

for some positive integer t .

Suppose there exist integers $s, k \in \{1, 2, \dots, N\}$ such that $s\overline{F}_N[t] < k \leq s\alpha$. Then k/s , suitably reduced, belongs to G_N and lies between $\overline{F}_N[t]$ and $\overline{F}_N[t+1]$, yielding a contradiction. It follows that $Q(\alpha; 0, N) \cap \{1, 2, \dots, N\} = Q(\overline{F}_N[t]; 0, N) \cap \{1, 2, \dots, N\}$. In other words, the number of quasi-progressions contained in $\{1, 2, \dots, N\}$ forms a polynomial-sized family.

In order to illustrate the difficulty of proving a stronger upper bound, we now introduce a natural family with very large discrepancy that properly contains quasi-progressions. The hypergraphs H_k are defined on the vertex $V = \{0, 1, \dots, n-1\}$. Let $0 \leq a_0 < a_1 < \dots < a_m < n$. Then the edge $\{a_0, a_1, \dots, a_m\}$ belongs to H_k if and only if $a_j - a_{j-1} = k$ or $k+1$ for all $j, 1 \leq j \leq m$. We shall refer to H_k as the hypergraph of *staircase sequences of stepsize k* .

Note that if $\alpha \in [k, k+1)$, the associated quasi-progression belongs to H_k . It is easy to see that H_k has asymptotically c^n edges, where c is the unique positive solution to the equation $c^{k+1} = c+1$. Let $\delta_k = 1/(k+1)$. Note that by intermediate value theorem, $c \in (1, 1 + \delta_k)$ for $k \geq 2$. We will now show that H_k has discrepancy at least $n/(2k^2 + o(k^2))$.

Let $\chi : V \rightarrow \{+1, -1\}$ be any 2-coloring of V , and let M be the discrepancy under this coloring. Assume without loss of generality that $|\{j : \chi(j) = 1\}| \geq |\{j : \chi(j) = -1\}|$. We define $\chi^* : V \rightarrow \{0, 1, 2, \dots, k\}$ as follows:

- $\chi^*(0) = (1 - \chi(0))/2$
- $0 \leq \chi^*(n) < k \Rightarrow \chi^*(n+1) = \chi^*(n) + 1$
- $\chi^*(n) = k$ and $\chi(n+1) = -1 \Rightarrow \chi^*(n+1) = 0$

- $\chi^*(n) = k$ and $\chi(n+1) = 1 \Rightarrow \chi^*(n+1) = 1$

Let $p_j = |\{i : \chi(i) = 1 \text{ and } \chi^*(i) = j\}|$, and let $m_j = |\{i : \chi(i) = -1 \text{ and } \chi^*(i) = j\}|$. Observe that $\{\chi^*(i) = j\}$ forms a staircase sequence of stepsize k , for $1 \leq j \leq k$. Note that $p_0 = 0$ and $m_0 \leq \sum_{j=1}^k (p_j - m_j) \leq kM$.

Observe that $\chi^*(j) = 1$ and $\chi(j) = -1$ imply that $\chi^*(j-1) = 0$ and $\chi(j-1) = -1$. Thus $m_1 \leq m_0 + 1 \leq kM + 1$ and $b_1 \leq m_1 + M \leq (k+1)M + 1$. But $m_1 + b_1 \geq n/(k+1)$. It follows that

$$M \geq \frac{n}{(k+1)(2k+1)} - \frac{2}{2k+1} = \frac{n}{2k^2 + o(k^2)}$$

In spite of this disheartening fact, it is actually possible to beat the random coloring upper bound for quasi-progressions, as mentioned in the beginning of this section.

Theorem 5 The hypergraph of quasi-progressions contained in $\{0, 1, \dots, N\}$ has discrepancy $O(N^{1/3+\epsilon})$.

Proof Let q be the largest integer such that $N \geq 8q^3$. Let $N = 2Aq + B$, $0 \leq B < 2q$. Recall that it suffices to consider the elements of $\overline{F_N}$, the inverse Farey sequence of order N . We divide the set $\{1, 2, \dots, N\}$ into A blocks of size $2q$, and a residual block of size $B = O(N^{1/3})$. Each block is colored with precisely one sign change at the halfway mark. Thus either the left half of the block is red and the right half is blue, or vice versa. Observe that the number of terms in the left and right halves of a given block differs by at most one, for any quasi-progression. Thus, with each $\overline{F_N}[i]$, we can associate a bias set $B_i \subseteq \{1, 2, \dots, 2A\}$, constructed as follows.

Consider the interesection of the quasiprogession corresponding to $\overline{F_N}[i]$ with the k^{th} block. We mandate that $2k - 1 \in B_i$ if and only if the left half of the k^{th} block contains more elements (in fact, one more element) than the right half, and

$2k \in B_i$ if and only if the right half of the k^{th} block contains more elements than the left half. Clearly, the discrepancy of the hypergraph of quasiprogessions differs from the discrepancy of the hypergraph of these bias sets by at most $O(N^{1/3})$. Since the latter is a polynomial family of hyperedges over a vertex set of size $O(N^{2/3})$, random coloring now yields an upper bound of $O(N^{1/3}\sqrt{\log N})$ for the discrepancy of bias sets, and consequently for the discrepancy of quasiprogessions. By increasing the block size by a logarithmic power, the upper bound can, in fact, be improved to $O((N \log N)^{1/3})$. ■

Not surprisingly, this argument also shows that the discrepancy of arithmetic progressions is $o(\sqrt{N})$, providing yet another refutation of a conjecture that stood a few years. Indeed, Sárközy's $O(N^{1/3+\epsilon})$ upper bound for the discrepancy of arithmetic progressions was founded on quite similar ideas, and had the added advantage of being deterministic, based as it was on properties of quadratic residues.

Chapter 4

Variations on Van der Waerden's Theorem

Monochromatic Van der Waerden Triples

By Van der Waerden's theorem, any 2-coloring of the integers admits arbitrarily long arithmetic progressions of the same color. In particular, there are monochromatic arithmetic progressions of length three in any 2-coloring of $\{1, 2, \dots, N\}$ for $N \geq 9$. A \$100 problem of Graham asks for the asymptotic number of monochromatic three-term arithmetic progressions that are inevitable in any 2-coloring of $\{1, 2, \dots, N\}$. The analogous question on Schur triples $\{x, y, x + y\}$ was answered by Robertson and Zeilberger [33], and independently by Schoen [36], who established that the minimum number of Schur triples is $N^2/22 + O(N)$.

The best known bounds on this problem are due to Parrilo, Robertson and Saracino [30] who showed, using semi-definite quadratic programming and a G5 Macintosh server, that the minimum number of monochromatic three-term arithmetic progressions is between $N^2/(19.5629\dots)$ and $N^2/(18.7350\dots)$. Note that the upper bound implies that random colorings, which yield $N^2/16$ monochromatic progressions, are not optimal. We obtain a lower bound using elementary harmonic analysis. Our technique is inspired by Roth's lower bound on the discrepancy of arithmetic progressions. While no records have been harmed in the production of this bound, we hope that our approach is of some independent interest.

Let χ be the given 2-coloring, whose domain is extended to \mathbf{Z} by defining it to

be 0 outside $[1, N]$. Let $\gamma_b(m) = 1$ if $m = -b, 0$ or b , and 0 otherwise. Define

$$F_b(m) = (\chi \star \gamma_b)(m) = \chi(m-b) + \chi(m) + \chi(m+b)$$

By Parseval's identity, we have

$$\sum_{m=1}^N |F_b(m)|^2 = \int_0^1 |\hat{F}_b(t)|^2 dt = \int_0^1 |\hat{\gamma}_b(t)|^2 |\hat{\chi}(t)|^2 dt$$

Note that the Fourier transform of γ_b is given by $\hat{\gamma}_b(t) = 1 + 2 \cos(2\pi bt)$. Thus,

$$|\hat{\gamma}_b(t)|^2 = 3 + 2 \cos(4\pi bt) + 4 \cos(2\pi bt)$$

Since the Dirichlet kernel given by

$$D_M(\theta) = \sum_{b=1}^M \cos(b\theta) = \frac{\sin((2M+1)(\theta/2))}{\sin(\theta/2)}$$

can be negative, we work with the non-negative Fejér kernel, given by

$$F_M(\theta) = \sum_{b=0}^M \left(1 - \frac{b}{M}\right) \cos(b\theta) = \frac{\sin^2((2M+1)(x/2))}{M \sin^2(x/2)}$$

Accordingly, for suitably chosen c and $M = cN$, we get

$$\sum_{b=1}^{cN} \left(1 - \frac{b}{cN}\right) \sum_{m=1}^N |F_b(m)|^2 = \int_0^1 \left(1 - \frac{b}{cN}\right) |\hat{\gamma}_b(t)|^2 |\hat{\chi}(t)|^2 dt \geq \frac{3}{2} cN^2$$

The upshot is that the average value of $|F_b(m)|^2$ is at least $3/2$. Since $|F_b(m)|^2$ equals 9 if the three-term progression is monochromatic and 1 if it is not, we expect this to yield a lower bound on monochromatic arithmetic progressions. However, the fact that some arithmetic progressions go out of bounds leads to complications, and calls for a judicious choice of c .

Let G_b be the number of 3-term monochromatic progressions with common difference b . Accounting for the contributions of $2b$ "fake" three-term arithmetic progressions, we have,

$$\sum_{b=1}^{cN} \left(1 - \frac{b}{cN}\right) (9G_b + (N - 2b - G_b) + 8b) \geq \frac{3}{2}cN^2$$

Rearranging terms, we get,

$$\frac{3}{2}cN^2 - \sum_{b=1}^{cN} (N + 6b) \left(1 - \frac{b}{cN}\right) \leq \sum_{b=1}^{cN} \left(1 - \frac{b}{cN}\right) 8G_b$$

A straightforward computation shows that

$$\frac{1}{cN} \sum_{b=1}^{cN} \left(1 - \frac{b}{cN}\right) \left(\frac{G_b}{N}\right) \geq \frac{1-c}{8}$$

Let $x = b/(cN) \in [0, 1]$ and let $f(x)$ denote the distribution function of G_b . Since $G_b \leq N - 2b$ for all b , we also require that $f(x) \leq 1 - 2cx$ for all x . We could walk away with $c = 1/2$ and $N^2/32$ monochromatic 3APs, but let us consider the following question:

Given $\int_0^1 (1-x)f(x) dx \geq (1-c)/8$ and $f(x) \leq 1 - 2cx, 0 \leq x \leq 1$, how small can $\int_0^1 f(x) dx$ be?

It is easy to see that “shifting the entire weight to the left” results in the least possible integral. Thus if a satisfies

$$\int_0^a (1-x)(1-2cx) dx = (1-c)/8$$

then we have

$$\int_0^1 f(x) dx \geq \int_0^a (1-2cx) dx = a(1-ac)$$

We are therefore interested in the solution of the following problem:

Maximize $ac(1-ac)$ subject to

$$(2c/3)a^3 - (2c+1)(a^2/2) + a - (1-c)/8 = 0$$

Since the question is one of optimization in the presence non-linear constraints, we use Lagrange multipliers. Define

$$L(a, c) = ac - a^2c^2 + \lambda[(2c/3)a^3 - ((2c + 1)/2)a^2 + a - (1 - c)/8]$$

Setting the partial derivatives equal to zero, we get

$$\begin{aligned} \frac{\partial L}{\partial a} &= (c - \lambda a + \lambda)(1 - 2ac) = 0 \\ \frac{\partial L}{\partial c} &= (a - 2a^2c) + \lambda[(2/3)a^3 - a^2 + (1/8)] = 0 \end{aligned}$$

Simplification leads to the following equations:

$$\begin{aligned} 32a^4 - 32a^3 + 60a^2 - 48a + 3 &= 0 \\ 24a(1 - a) + c(32a^3 - 24a^2 - 3) &= 0 \end{aligned}$$

Solving these, we get $a = 0.0681\dots$ and $c = 0.4911\dots$, yielding $N^2/(30.9335\dots)$ monochromatic three-term arithmetic progressions.

Discrepancy in Progressions of Fixed Length

We now study a variation of Van der Waerden's theorem introduced by Erdős and Graham [17]. Let $f(n, k)$ denote the least integer such that every 2-coloring of $\{1, 2, \dots, f(n, k)\}$ admits an n -term arithmetic progression whose discrepancy exceeds k . Spencer (see [39]) showed that $f(n, 0) = (n - 1)g(n) + 1$ where $g(n)$ denotes the largest power of 2 that divides n . Erdős and Graham made three conjectures on the growth of $f(n, k)$, in increasing order of difficulty:

- $\lim [f(n, 1)]^{1/n}$ is finite.
- $\lim [f(n, \sqrt{n})]^{1/n}$ is finite.
- $\lim [f(n, cn)]^{1/n}$ is finite for some positive constant c .

We prove the first, and almost prove the second. Specifically, we show the following:

Theorem 6 $f(n, k) = O(n^2)$ for $k < (1/\sqrt{2} - \epsilon)\sqrt{n}$

Proof The basic idea is already outlined in the previous section. Instead of 3-term arithmetic progressions, we now take $(2L + 1)$ -term arithmetic progressions with small common difference (to ensure that very few progressions go out of bounds) and use Parseval's identity and the Fejér kernel to show that the average discrepancy is about \sqrt{L} .

For brevity, let $M = f(n, k)$. As before, let χ denote the given 2-coloring, extended to \mathbf{Z} by defining it to be 0 outside $[1, M]$. Let $\gamma_b(m) = 1$ if $m = 0, \pm b, \pm 2b, \dots, \pm Lb$, and 0 otherwise. Define

$$F_b(m) = (\chi \star \gamma_b)(m) = \sum_{q=-L}^L \chi(m + qb)$$

By Parseval's identity, we have

$$\sum_{m=1}^M |F_b(m)|^2 = \int_0^1 |\hat{F}_b(t)|^2 dt = \int_0^1 |\hat{\gamma}_b(t)|^2 |\hat{\chi}(t)|^2 dt$$

The Fourier transform of γ_b is given by $\hat{\gamma}_b(t) = 1 + 2 \sum_{q=1}^L \cos(2\pi qbt)$. Thus,

$$|\hat{\gamma}_b(t)|^2 = (2L + 1) + 2 \sum_{q=1}^L \cos(4\pi qbt) + 8 \sum_{q=1}^L \sum_{r=q+1}^L \cos(2\pi qbt) \cos(2\pi rbt)$$

Using the non-negativity of the Fejér kernel and the identity $2 \cos A \cos B = \cos(A + B) + \cos(A - B)$, we get,

$$\sum_{b=1}^{cM} \left(1 - \frac{b}{cM}\right) \sum_{m=1}^M |F_d(m)|^2 = \int_0^1 \left(1 - \frac{b}{cM}\right) |\hat{\gamma}_b(t)|^2 |\hat{\chi}(t)|^2 dt \geq \frac{2L+1}{2} cM^2$$

Note that at most $4Lb$ arithmetic progressions with $2L + 1$ terms and common difference b can go out of bounds. Thus the contribution of fake arithmetic progressions is less than $2L^3c^2M^2$. It follows that by choosing $c < 1/((2 + \epsilon)L^2)$ and $f(n, k) = M \gg 1/c$, we can ensure that there is an arithmetic progression with $2L + 1$ terms and discrepancy $\lfloor \sqrt{L} \rfloor$.

Chapter 5

The Hales–Jewett Number is Exponential

The Hales–Jewett number

One of the cornerstones of Ramsey theory is the Hales–Jewett theorem, which states that every k -coloring of the n^d hypercube gives rise to a monochromatic n -in-a-line, when d is sufficiently large. In fact, the proof of Hales and Jewett guarantees the existence of a monochromatic *combinatorial line*. This motivates two distinct thresholds, $HJ(n)$ and $HJ^c(n)$, defined as follows.

Recall that a combinatorial n -in-a-line is a 1-parameter set, naturally encoded as a string of length n , with at most $n - 1$ positions in the string occupied by constants from 1 to n and at least one position occupied by the *up* symbol (denoted by \uparrow). The value of \uparrow runs from 1 through n , generating the n points that lie on the line. Seven of the eight winning lines in ordinary (3^2) tic-tac-toe are combinatorial lines, encoded as $(1, \uparrow)$, $(2, \uparrow)$, $(3, \uparrow)$, $(\uparrow, 1)$, $(\uparrow, 2)$, $(\uparrow, 3)$ and (\uparrow, \uparrow) respectively. The North West - South East diagonal is not a combinatorial line.

Lines as we know them will be referred to in this chapter as *geometric lines*. Every combinatorial line is a geometric line, but not conversely. Geometric lines are encoded using an additional *down* symbol (denoted by \downarrow). Once again, not all positions can be occupied by constants. Furthermore, the values of \uparrow and \downarrow , whenever they both occur in a string, must add up to $n + 1$. The non-combinatorial line in 3^2 tic-tac-toe is encoded as (\uparrow, \downarrow) . It is clear from the definition that there are

substantially more geometric lines than combinatorial lines: in the n^d Tic-Tac-Toe game there are $((n+2)^d - n^d)/2$ geometric lines and $(n+1)^d - n^d$ combinatorial lines. Note that every geometric line has two orientations.

The Hales–Jewett threshold $HJ(n, k)$ is the smallest integer d such that in each k -coloring of the points of n^d there is a monochromatic *geometric* line. The modified Hales–Jewett threshold $HJ^c(n, k)$ is the smallest integer d such that in each k -coloring of n^d there is a monochromatic *combinatorial* line. Clearly,

$$HJ(n, k) \leq HJ^c(n, k).$$

In the case of “two colors” ($k = 2$) we write: $HJ(n) = HJ(n, 2)$ and $HJ^c(n) = HJ^c(n, 2)$.

In 1963 Hales and Jewett made the crucial observation that Van der Waerden’s famous double-induction argument used to establish his well-known theorem about monochromatic arithmetic progressions can be adapted to the n^d hypercube. Accordingly, they succeeded in proving that $HJ^c(n, k) < \infty$ for all positive integers n and k . This, of course, implies $HJ(n, k) < \infty$ for all positive integers n and k .

How large is $HJ(n) = HJ(n, 2)$? This is a famous open problem. In spite of all efforts, our present knowledge on the Hales–Jewett number $HJ(n)$ is still rather disappointing. The best known upper bound on $HJ(n)$ was proved by Shelah [37]. For a precise discussion of this bound we have to introduce the so-called Grzegorzcyk hierarchy of primitive recursive functions.

Let $g_1(n) = 2n$, and for $i > 1$, let $g_i(n) = g_{i-1}(g_{i-1}(\dots g_{i-1}(1) \dots))$, where g_{i-1} is taken n times. An equivalent definition is $g_i(n+1) = g_{i-1}(g_i(n))$. For example, $g_2(n) = 2^n$ is the exponential function,

$$g_3(n) = 2^{2^{2^{\dots^2}}}$$

is the “tower function” of height n . Note that $g_k(x)$ is the *representative* function of the $(k + 1)$ st Grzegorzcyk class.

In 1988, Shelah proved that $HJ^c(n, k)$, and therefore $HJ(n, k)$, are primitive recursive.

Theorem E For every $n \geq 1$ and $k \geq 1$,

$$HJ^c(n, k) \leq \frac{g_4(n + k + 2)}{(n + 1)k}$$

In other words, given any k -coloring of the hypercube n^d , where the dimension $d \geq \frac{g_4(n+k+2)}{(n+1)k}$, there is always a monochromatic *combinatorial* line.

An easy case-study shows that $HJ(3) = HJ^c(3) = 3$, but the numerical value of $HJ(4)$ remains a mystery. We know that it is at least 5 (see [21]), but no one can prove a “reasonable” upper bound like $HJ(4) \leq 1000$ or even a much weaker bound like $HJ(4) \leq 10^{1000}$. Shelah’s proof gives the explicit upper bound

$$HJ(4) \leq HJ^c(4) \leq g_3(24) = 2^{2^{2^{\dots^2}}}$$

where the “height” of the tower is 24.

A new lower bound

In their original paper Hales and Jewett (see [23]) proved a linear lower bound for the Hales–Jewett number: $HJ(n) \geq n$. Here we improve this to an *exponential* lower bound.

Theorem 7 The Hales-Jewett number is exponential.

$$HJ(n) \geq \frac{2^{n/4}}{\sqrt{e} n^{5/2}}$$

To illustrate the idea on a simpler example, we start the discussion with $HJ^c(n)$.

We recall Van der Waerden's famous combinatorial theorem on arithmetic progressions. For all positive integers n and k , there exists an integer W such that, if the set of integers $\{1, 2, \dots, W\}$ is k -colored, then there always exists a monochromatic n -term arithmetic progression. Let $W(n, k)$ be the least such integer; we call it the Van der Waerden threshold. For $k = 2$ we simply write $W(n) = W(n, 2)$.

The following one-sided inequality between the Van der Waerden threshold and the ‘‘combinatorial’’ Hales–Jewett threshold appears to be folklore:

$$\frac{W(n, k) - 1}{n - 1} \leq HJ^c(n, k)$$

To prove this, write $W = HJ^c(n, k) \cdot (n - 1)$, and let χ denote an arbitrary k -coloring of the interval $[0, W] = \{0, 1, 2, \dots, W\}$; we want to show that there is a monochromatic n -term arithmetic progression in $[0, W]$. Consider the d -dimensional hypercube $[n]^d$ with $d = HJ^c(n)$, where, as usual, $[n] = \{1, 2, \dots, n\}$. Let $\mathbf{w} = (a_1, a_2, \dots, a_d) \in [n]^d$ be an arbitrary point in the hypercube. We can define the color of a point \mathbf{w} as the χ -color of the coordinate-sum

$$g(\mathbf{w}) = (a_1 - 1) + (a_2 - 1) + (a_3 - 1) + \dots + (a_d - 1)$$

We refer to this particular k -coloring of hypercube $[n]^d$ as the ‘‘lift-up of χ ’’. Since the dimension of the hypercube is $d = HJ^c(n)$, there is a monochromatic combinatorial line in $[n]^d$ (monochromatic in the ‘‘lift-up of χ ’’). Thus the coordinate-sums of the n points on the line form a χ -monochromatic n -term arithmetic progression in $[0, W]$. This completes the proof.

In order to apply this inequality, we need a lower bound on the Van der Waerden number $W(n)$. Berlekamp [8] proved the following:

Theorem F $W(n) > (n - 1)2^{n-1}$ if n is a prime.

Combining this with the above inequality, we get

$$HJ^c(n) \geq 2^{n-1}$$

In general, for an arbitrary n (which is not necessarily a prime), a slightly weaker bound can be obtained using the symmetric version of the well-known Local Lemma (see [16]), stated below:

The Local Lemma Let A_1, A_2, \dots, A_n be events in some probability space, with each A_i mutually independent of all but at most d of the remaining events. Further, suppose that $Pr(A_i) \leq p, 1 \leq i \leq n$. If $ep(d + 1) \leq 1$, then with positive probability, *none* of the events A_i occur.

The Local Lemma yields the lower bound $W(n) \geq 2^{n-3}/n$; this implies

$$HJ^c(n) \geq \frac{2^{n-3}}{n^2}$$

Notice that these lower bounds are exponential.

We now obtain a similar bound on $HJ(n)$. We need the following generalization of arithmetic progressions. A sequence of integers a_1, a_2, \dots, a_n is said to be a *quadratic progression* if there exist integers A, B and C such that $2a_k = Ak^2 + Bk + C, 1 \leq k \leq n$. The quadratic progression is said to be degenerate if $A = 0$ and $B = 0$.

Motivated by the Van der Waerden threshold, we define $W_q(n, 2)$ to be the least integer such that any 2-coloring of $\{0, 1, \dots, W_q(n, 2) - 1\}$ yields an n -term non-degenerate quadratic progression. Clearly, $W_q(n, 2) \leq W(n, 2)$. We derive a lower bound on $W_q(n, 2)$.

Lemma 7.1 $W_q(n, 2) \geq (2^{n/4})/(\sqrt{en})$

Proof Let $\{Q_i\}$ be an enumeration of the non-degenerate n -term quadratic progressions contained in $\{0, 1, \dots, M\}$. Since no element occurs more than twice in a non-degenerate quadratic progression, we have

$$Pr(Q_i \text{ is monochromatic}) < 2^{-n/2}$$

Note that three consecutive terms completely determine a quadratic progression. Thus, any n -term quadratic progression contained in $\{0, 1, \dots, M\}$ intersects fewer than nM^2 quadratic progressions. By the Local Lemma, there exists a 2-coloring with no Q_i monochromatic for $M \leq (en)^{-1/2} 2^{n/4}$.

Proof of Theorem 7 We define the following function from the set of points in the n^d hypercube to the set of non-negative integers:

$$f(a_1, a_2, \dots, a_d) = \sum_{k=1}^d a_k^2$$

Any geometric line can be encoded as a string of length d over the alphabet $\Lambda = \{0, 1, \dots, n-1, x, \bar{x}\}$. Conversely, any string of length d over Λ containing at least one x or \bar{x} corresponds to a geometric line. The n points P_0, P_1, \dots, P_{n-1} constituting the line can be obtained by substituting $0, 1, \dots, n-1$ (respectively $n-1, n-2, \dots, 0$) for x (respectively \bar{x}).

Let $Q = (2^{n/4})/(\sqrt{en})$. From Lemma 1, there exists a coloring χ that avoids monochromatic n -term quadratic progressions in $\{0, 1, \dots, Q-1\}$. We color the point P with the color $\chi(f(P))$. Clearly, if P_0, P_1, \dots, P_{n-1} lie on a line L , then the sequence $f(P_0), f(P_1), \dots, f(P_{n-1})$ is a quadratic progression. Let the encoding of L over Λ contain a occurrences of x and b occurrences of \bar{x} . Since $f(P_0) - 2f(P_1) + f(P_2) = 2(a+b) \neq 0$, it follows that the progression is not degenerate.

For $d \leq Q/n^2$, we have $f(P) < Q$ for all points P . By definition of χ , there are no monochromatic quadratic progressions in $\{0, 1, \dots, Q - 1\}$. Therefore, our coloring does not give rise to monochromatic geometric lines. This completes the proof. ■

Chapter 6

Positional Games, Paradoxes and Progressions

Introduction

We consider positional games played on a hypergraph where two players alternately choose elements of the vertex set, the winner being the first to occupy an entire hyperedge. Canonical examples include tic-tac-toe and its higher-dimensional cousins we encountered in the previous chapter. Standard tic-tac-toe corresponds to the vertex set $\{1, 2, \dots, 9\}$ and edge set $\{(1, 2, 3), (4, 5, 6), (7, 8, 9), (1, 4, 7), (2, 5, 8), (3, 6, 9), (1, 5, 9), (3, 5, 7)\}$. The realization that this game is a draw with optimal play was one of the formative experiences of the author's childhood. We mention in passing that 4^3 tic-tac-toe is a first-player win (see [31]) and 5^3 tic-tac-toe is widely believed to be a draw, although in the latter case combinatorial explosion kills any mixture of diligent and automated case studies. The interested reader is referred to Beck [7] for a fascinating analysis of tic-tac-toe and other positional games using potential functions. Of course, there is already a well-established theory for games that decompose additively into smaller games, due to Berlekamp, Conway and Guy (see [13] and [9]).

Let P_1 and P_2 denote the first and second player respectively. It can be shown by a strategy stealing argument that P_2 cannot force a win in any hypergraph game. We give two examples of the so-called *Extra Set Paradox* for 3-uniform hypergraphs, where the game is a draw on the entire hypergraph, but P_1 wins on a proper (edge or vertex induced) subgraph. Our example for the edge-induced case is minimal (see

[28] for other examples), and the existence of the vertex-induced extra set paradox for uniform hypergraphs was an open question, albeit widely believed. Non-uniform examples are easier to construct, but most of the natural and interesting examples in the context of games correspond to uniform hypergraphs.

The Uniform Edge Induced Extra Set Paradox

Consider the hypergraph $H = (V, E)$ where $V = \{1, 2, \dots, 7\}$ and $E = \{(1, 2, 3), (1, 2, 4), (1, 2, 5), (1, 3, 4), (1, 5, 6), (3, 5, 7)\}$.

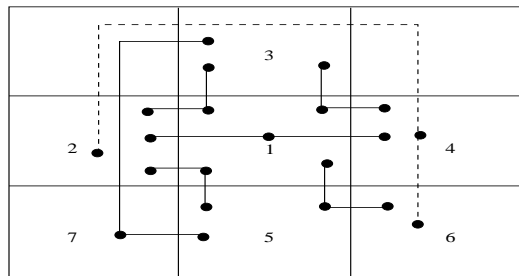

P_1 can force a win on this hypergraph as follows:

Move 1: P_1 picks 1. P_2 is forced to pick 2, for otherwise P_1 will pick 2 and seal the game, since at most two edges can be blocked in two moves.

Move 2: P_1 picks 3. P_2 is forced to pick 4 (immediate threat).

Move 3: P_1 picks 5. P_2 is forced to pick 6 (immediate threat).

Move 4: P_1 picks 7 and wins.

Now, let $E' = E \cup \{(2, 4, 6)\}$. We claim that the game played on $H' = (V, E')$ is a draw with optimal play.

In order to have any chance of winning, P_1 must pick vertex 1 in the first move. P_2 responds by picking 2.

If P_1 picks 3 (respectively 5) in Move 2, P_2 picks 4 (respectively 6). P_1 is then forced to pick 6 (respectively 4) and P_2 picks 5 (respectively 3), forcing a draw.

If P_1 picks 4 (respectively 6) in Move 2, P_2 picks 3 (respectively 5), forcing a draw. Clearly, picking 7 in the second move makes a draw easier for P_2 .

Thus P_2 can always force a draw. Furthermore, it is clear that any such example requires at least seven vertices, since extra edges cannot prevent a three-move win.

The Uniform Vertex Induced Extra Set Paradox

We show that concerns about vertex-induced extra set paradoxes occurring in reasonable games are not entirely out of place.

Theorem 8 The vertex-induced extra edge paradox does occur in uniform hypergraphs.

Proof Consider the hypergraph $H'' = (V'', E'')$ where $V'' = \{1, 2, \dots, 9\}$ and $E'' = \{(1, 2, 3), (1, 2, 4), (1, 2, 5), (1, 3, 4), (1, 5, 6), (3, 5, 7), (2, 4, 8), (2, 6, 9)\}$.

As we have already seen, the first player can force a win on the subgraph induced by the vertex set $\{1, 2, \dots, 7\}$. We claim that the game on the entire hypergraph is a draw with optimal play.

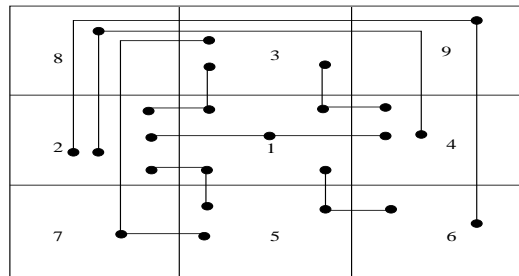

In order to have any chance of winning, P_1 must pick vertex 1 in the first move. P_2 responds by picking 2.

If P_1 picks 3 (respectively 5) in Move 2, P_2 picks 4 (respectively 6). P_1 is then forced to pick 8 (respectively 9) and P_2 picks 5 (respectively 3), forcing a draw.

If P_1 picks 4 (respectively 6) in Move 2, P_2 picks 3 (respectively 5), forcing a draw. Clearly, picking 7, 8 or 9 in the second move makes a draw easier for P_2 .

We conclude that P_2 can always force a draw.

Extra set paradoxes cannot occur if one player focuses on building a configuration and the other player focuses on blocking the configuration. This motivates the study of Maker-Breaker games. For example, consider a variant of tic-tac-toe where the first player (Maker) aims to occupy three cells in a straight line, and the second player (Breaker) tries to prevent Maker from doing so. It is easy to show that Maker has a winning strategy in this game.

The 4AP Game

We now consider a family of hypergraph games motivated by Van der Waerden's theorem. In the regular version, denoted by $G(n, k)$ both players color previously uncolored integers from 1 to n with their own designated colors, and the winner is the first to occupy a monochromatic k -term arithmetic progression. In the Maker-Breaker version, denoted by $G^*(n, k)$, the first player (Maker) tries to occupy a monochromatic arithmetic progression and the second player (Breaker) tries to prevent Maker from doing so. In a pioneering paper on the subject, Beck [4] proved the following threshold estimates:

Theorem G The Maker-Breaker game $G^*(n, k)$ is a win for Maker if $n > (2 + o(1))^k$ and a win for Breaker if $n < (2 - o(1))^k$.

By Van der Waerden's theorem, $G(n, k)$ cannot end in a draw for fixed k and sufficiently large n . Strategy stealing ensures that P_1 has a winning strategy. Clearly, any winning strategy for P_1 in $G(n, k)$ is also a winning strategy for Maker in $G^*(n, k)$. It is easy to see that P_1 wins both $G(n, 3)$ and $G^*(n, 3)$ for $n \geq 5$. We investigate the case $k = 4$ in detail. We believe that $k = 5$ is beyond hope, and admonish anyone

who balks at the following case analysis to count their blessings.

We first show that P_2 can force a draw in $G(10, 4)$ using a pairing strategy. To this end, P_2 partitions the set of vertices into five pairs, namely $(1, 2)$, $(3, 5)$, $(4, 7)$, $(6, 8)$ and $(9, 10)$. Whenever P_1 occupies a vertex, P_2 occupies the other vertex in the pair. It can be easily verified that every 4-term arithmetic progression in $\{1, 2, \dots, 10\}$ contains one of the above five pairs. Thus P_1 cannot win.

We now prove that (given the opening move) Maker wins $G^*(14, 4)$. Maker opens with 7. Note that if Breaker responds with a number that does not belong to the set $\{5, 6, 8, 9, 10, 11, 13\}$, Maker can ensure victory by picking 9. Similarly, if Breaker's first move does not belong to the set $\{1, 3, 4, 5, 6, 8, 9\}$, Maker seals the game by picking 5. It follows that Breaker's first move must be 5, 6, 8 or 9.

Case 1: Breaker picks 5. Maker plays 10, forcing Breaker to cover 1, 4 or 13. Maker wins with $8 \rightarrow 9 \rightarrow 12$. (Note that unlike the regular version, Breaker cannot win by occupying the progression $\{1, 5, 9, 13\}$.)

1	2	3	4	5	6	7	8	9	10	11	12	13	14
b_1			b_2	a	*	A	C	c	B		D	b_3	*

Case 2: Breaker picks 6. Maker plays 10, forcing Breaker to cover 1, 4 or 13. Maker wins with $9 \rightarrow 8 \rightarrow 5$.

1	2	3	4	5	6	7	8	9	10	11	12	13	14
b_1		*	b_2	D	a	A	c	C	B	*		b_3	

Case 3: Breaker picks 8. Maker plays 4, forcing Breaker to cover 1, 10 or 13. Maker wins with $5 \rightarrow 6 \rightarrow 9$.

1	2	3	4	5	6	7	8	9	10	11	12	13	14
b_1		*	B	C	a	A	c	D	b_2	*		b_3	

Case 4: Breaker picks 9. Maker plays 4, forcing Breaker to cover 1, 10 or 13.

If Breaker plays 1, Maker wins with $6 \rightarrow 5 \rightarrow 8$.

1	2	3	4	5	6	7	8	9	10	11	12	13	14
b	*		B	c	C	A	D	a	*				

If Breaker plays 10 or 13, Maker wins with $5 \rightarrow 6 \rightarrow 3$.

1	2	3	4	5	6	7	8	9	10	11	12	13	14
*	*	D	B	C	c	A		a	b_1			b_2	

Finally, we show that P_1 wins $G(15, 4)$. P_1 picks 8 to start. Without loss of generality, P_2 responds with an integer from 1 to 7.

Case 1: P_2 does not pick 6 or 7. P_1 picks 10 and wins, since P_2 must simultaneously cover $(6, 12, 14)$ and $(7, 9, 11)$ to avoid a fork.

Case 2: P_2 plays 7. P_1 picks 10, forcing P_2 to cover 6 or 12 to avoid a fork. P_1 wins with $11 \rightarrow 9 \rightarrow 5$.

1	2	3	4	5	6	7	8	9	10	11	12	13	14	15
	*			D	b_1	a	A	c	B	C	b_2			*

Case 3: P_2 plays 6. P_1 picks 11, forcing P_2 to cover 2, 5 or 14 to avoid a fork.

If P_2 picks 5, P_1 wins with $9 \rightarrow 10 \rightarrow 13$.

1	2	3	4	5	6	7	8	9	10	11	12	13	14	15
				b	a	*	A	C	c	B		D		*

If P_2 picks 2 or 14, P_1 plays 9, forcing P_2 to play 10. P_1 then picks 14 or 2, whichever is free. P_2 is forced to cover 5. P_1 picks 13 and wins.

1	2	3	4	5	6	7	8	9	10	11	12	13	14	15	
	b_1/D				d	a	*	A	C	c	B		E	b_2/D	*

While the uniform vertex-induced Extra Set Paradox can, in general, give rise to fuzzy thresholds, the above proof makes it clear that $G(n, 4)$ is a first-player win for $n \geq 15$. Implicit in the statement of the above results are the following conjectures.

- Breaker wins $G^*(13, 4)$.
- $G(14, 4)$ is a draw.

These questions may well be within the reach of an exhaustive computer search, but we hope it need not come to that.

A New Goal : Homogeneous Arithmetic Progressions

We consider a family of Maker-Breaker games where the players, alternately color the (uncolored) elements of $\{1, 2, \dots, N\}$ red and blue until all elements are colored. Maker wins if (s)he has a lead of ℓ on some arithmetic progression containing 0 and Breaker wins otherwise.

Theorem 9 Let $\varepsilon > 0$ be given, together with the required lead ℓ for the discrepancy game with homogeneous arithmetic progressions. Maker wins if $\ell < N^{\frac{1}{2}-\varepsilon}$

and Breaker wins if $\ell > N^{\frac{1}{2}-\varepsilon}$ for sufficiently large N .

Proof For every $\varepsilon > 0$, we exhibit an explicit winning strategy for Maker (respectively Breaker) if $\ell < N^{\frac{1}{2}-\varepsilon}$ (respectively $\ell > N^{\frac{1}{2}+\varepsilon}$), for sufficiently large N . The proofs make use of potential functions introduced by Beck (see [6]).

We begin by deriving Maker's strategy. Let N be sufficiently large, and let P_N denote the set of primes not exceeding N . Let $k = \lceil \frac{1}{2\varepsilon} \rceil$. Define $P^* = \{p \in P_N : N/2 < p^k < N\}$ and let U denote the set of all k -fold products of distinct elements in P^* . Let $|P^*| = m$ and $|U| = n \doteq \binom{m}{k}$. Observe that for every $Q \subseteq P^*$ with $|Q| = k$, there is a unique integer $q \in [1, N]$ such that q is divisible by all the elements in Q . Furthermore, this integer q belongs to U .

Maker shall secure the required lead on an arithmetic progression of the form $A_p \doteq \{0, p, 2p, \dots\} \cap S_N$ where $p \in P^*$. Let \mathcal{F} denote the family of such arithmetic progressions. We associate a counter c_i with each element $A_{p_i} \in \mathcal{F}$. The counter C_i is initialized to 0, and incremented (respectively decremented) by 1 every time Maker (respectively Breaker) chooses a multiple of p_i . We shall denote the value of C_i at the end of Breaker's t^{th} move by $c_{i,t}$.

Maker begins by choosing 0. For all further moves, Maker will choose uncolored elements of U . Suppose the elements $0, v_1, u_2, v_2, \dots, u_t, v_t$ were chosen already and it is Maker's turn. Note that

$$\sum_{i=1}^m c_{i,t} \geq \sum_{i=1}^m c_{i,1} \geq m - k > 0$$

For $u \in U$, define $f_t(u) = f_t(p_{i_1} \cdots p_{i_k}) = c_{i_1,t} + \cdots + c_{i_k,t}$. Maker chooses the element u_t^* that maximizes the value of f_t over all uncolored elements of U . Let

$m^* \doteq \sqrt{\frac{m^{k-1}}{5^k k!}}$ and $x^+ \doteq \max(x, 0)$. Consider the potential function

$$V_t = \sum_{i=1}^m [(c_{i,t} + m^*)^+]^2$$

A straightforward computation shows that irrespective of Breaker's reply, the potential function will increase by at least 2, provided the counters associated with u_t^* satisfy $c_{i,r,t} \geq -m^* \forall r \in \{1, 2, \dots, k\}$. We claim that Maker can find u_t^* with this property for the first $n_0 \doteq \binom{m/3}{k}$ moves.

Call a progression A_{p_i} *unbreakable* if $c_{i,t} \geq \frac{m^*}{2k}$. Note that if we have an unbreakable progression, then we are done immediately, since any lead can be sustained.

If there are no unbreakable progressions, the family \mathcal{F}' of progressions A_{p_j} satisfying $c_{j,t} > -\frac{m^*}{2k}$ has at least $\frac{m}{2}$ elements, and the claim will follow if we can show that $f_t(u_t^*) > -\frac{m^*}{2}$. Note that for the first n_0 moves, there exist distinct progressions $A_{p_{j_1}}, \dots, A_{p_{j_k}} \in \mathcal{F}'$ such that $u_t' \doteq p_{j_1} \cdots p_{j_k}$ is not colored and $c_{j_r,t} > -\frac{m^*}{2k} \forall r \in \{1, 2, \dots, k\}$, yielding $f_t(u_t^*) \geq f_t(u_t') > -\frac{m^*}{2}$, as required.

Thus, at the end of n_0 moves, the potential reaches a value $V_{t_0} > n_0 > \frac{m^k}{4^k k!}$. Therefore, there exists i_0 satisfying

$$c_{i_0, t_0} > m^* > cN^{\frac{1}{2}-\varepsilon} > \ell$$

Having established the required lead on $A_{p_{i_0}}$, Maker picks uncolored elements from this progression and retains the advantage till the end.

We now establish a threshold for Breaker. Let $\{P_i\}$ be an enumeration of the arithmetic progressions in $\{0, 1, \dots, N\}$, containing 0. Suppose $x_1, y_1, x_2, y_2, \dots, x_k$ are already chosen and it is Breaker's turn. Let m_i and b_i denote the number of

elements in P_i that are chosen by Maker and Breaker respectively. Let

$$w_k(P_i) \doteq \left(1 + \frac{1}{\sqrt{N}}\right)^{m_i} \left(1 - \frac{1}{\sqrt{N}}\right)^{b_i} \text{ and } T_k \doteq \sum_i w_k(P_i)$$

The weight of any element x is given by

$$w_k(x) = \sum_{x \in P_i} w_k(P_i)$$

Breaker chooses y_k of maximal weight among the uncolored elements. Note that $T_1 = |\{P_i\}| \ll N \ln N$. Furthermore,

$$T_{k+1} \leq T_k - \frac{w_k(y_k) - w_k(x_{k+1})}{\sqrt{N}} \leq T_k$$

Suppose $\exists i$ such that $m_i - b_i > 2\sqrt{N} \ln N$. Since $(1 - \frac{1}{N})^{b_i} > e^{-1}$, we get $w_k(P_i) \gg N^2$, a contradiction. It follows that Breaker can always prevent a lead of $N^{\frac{1}{2}+\epsilon}$, for sufficiently large N .

References

- [1] N. Alon and J. Spencer, *The Probabilistic Method*, Academic Press, New York, 1992.
- [2] J. Beck, *Roth's estimate of the discrepancy of integer sequences is nearly sharp*. *Combinatorica* 1, 1981.
- [3] J. Beck, *On positional games*. *Journal of Combinatorial Theory, Series A* 30, 1981.
- [4] J. Beck, *Van der Waerden and Ramsey type games*. *Combinatorica* 2, 1981.
- [5] J. Beck, *On irregularities of ± 1 -sequences*. *Österreich. Akad. Wiss. Math.-Natur. Kl. Sitzungsber II* 195, 1986.
- [6] J. Beck, *Deterministic graph games and a probabilistic intuition*. *Combinatorics, Probability and Computing* 3, 1994.
- [7] J. Beck, *Tic-Tac-Toe Theory*. Cambridge University Press, 2007.
- [8] E. R. Berlekamp, *A construction for partitions which avoid long arithmetic progressions*. *Canad. Math. Bull.* 11, 1968.
- [9] E. R. Berlekamp, J. H. Conway and R. K. Guy, *Winning Ways for your Mathematical Plays*. Academic Press, New York, 1982.
- [10] N. Chevallier, *Geometrie des suites de Kronecker*. *Manuscripta Math.* 94, 1997.
- [11] N. Chevallier, *Three distance theorem and grid graph*. *Discrete Mathematics* 223, 2000.
- [12] F. R. K. Chung and R. L. Graham, *On the set of distances determined by the union of arithmetic progressions*. *Ars Combinatoria* 1, 1976.
- [13] J. H. Conway, *On Numbers and Games*. Academic Press, New York, 1976.
- [14] P. Erdős and J. Selfridge, *On a combinatorial game*. *Journal of Combinatorial Theory, Series A*, 14, 1973.
- [15] P. Erdős and J. Spencer, *Probabilistic Methods in Combinatorics*. Akadémiai Kiadó, Budapest, 1974.
- [16] P. Erdős and L. Lovász, *Problems and results on 3-chromatic hypergraphs and some related questions.*, in: *Infinite and Finite Sets*, Colloq. Math. Soc. Janos Bolyai, Vol. 11. North-Holland, Amsterdam, 1975.

- [17] P. Erdős and R. Graham, *Old and New Problems and Results in Combinatorial Number Theory*. L' Enseignement Mathématique, Geneva, 1980.
- [18] P. Erdős, *On the combinatorial problems which I would most like to see solved*. *Combinatorica* 1, 1981.
- [19] D. Gale, *The game of Hex and the Brouwer fixed-point theorem*. *American Mathematical Monthly* 86, 1979.
- [20] J. F. Geelen and R. J. Simpson, *A two-dimensional Steinhaus theorem*, *Australasian Journal of Combinatorics* 8, 1993.
- [21] S. W. Golomb and A. W. Hales, *Hypercube Tic-Tac-Toe*, in: *More on Games of No Chance*, MSRI Publications, Vol. 42, 2002.
- [22] R. L. Graham, B. L. Rothschild and J. H. Spencer, *Ramsey Theory*. Wiley-Interscience Series in Discrete Math., New York, 1980.
- [23] A. W. Hales and R. I. Jewett, *On regularity and positional games*, *Trans. Amer. Math. Soc.* 106, 1963.
- [24] G. H. Hardy and E. M. Wright, *An Introduction to the Theory of Numbers*. Clarendon Press, Oxford, 1938.
- [25] R. Hochberg, *Discrepancy and Bandwidth*. Ph.D. Thesis, Rutgers University, 1994.
- [26] R. Hochberg, *Large Discrepancy in Homogeneous Quasi-arithmetic Progressions*. *Combinatorica* 26, 2006.
- [27] L. Kuipers and H. Niederreiter, *Uniform Distribution of Sequences*. Wiley-Interscience, New York, 1974.
- [28] K. Kruczek, *Tic-Tac-Toe and Tumbleweeds*. Ph.D. Thesis, Rutgers University, 2004.
- [29] J. Matoušek and J. Spencer, *Discrepancy in arithmetic progressions*. *Journal of the American Mathematical Society* 9, 1996.
- [30] P. Parrilo, A. Robertson and D. Saracino, *On the asymptotic minimum number of monochromatic 3-term arithmetic progressions*. arXiv:math.CO/0609532, Preprint.
- [31] O. Patashnik, *Qubic: $4 \times 4 \times 4$ Tic-Tac-Toe*, *Mathematics Magazine* 53, 1980.
- [32] D. Reimer, *Five Coloring Theorems*. Ph.D. Thesis, Rutgers University, 1997.
- [33] A. Robertson and D. Zeilberger, *A 2-coloring of $[1, N]$ can have $(1/22)N^2$ monochromatic Schur triples, but not less!* *Electronic Journal of Combinatorics* 5, 1998.

- [34] K. F. Roth, *On irregularities of distribution*. Mathematika 1, 1954.
- [35] K. F. Roth, *Remark concerning integer sequences*. Acta Arithmetica 9, 1964.
- [36] T. Schoen, *The number of monochromatic Schur triples*. European Journal of Combinatorics 20, 1999.
- [37] S. Shelah, *Primitive recursive bounds for Van der Waerden numbers*. Journal of the American Math. Soc. 1, 1988.
- [38] V. T. Sós, *On the distribution mod 1 of the sequence $\{n\alpha\}$* . Ann. Univ. Sci. Budapest, Eotvos Sect. Math. 1, 1958.
- [39] J. H. Spencer, *Solution to Problem P. 185*. Canadian Mathematical Bulletin 16, 1973.
- [40] S. Świerczkowski, *On successive settings of an arc on the circumference of a circle*. Fund. Math. 46, 1958.
- [41] L. A. Székely, *On two concepts of discrepancy in a class of combinatorial games*, in: Finite and Infinite Sets, Colloq. Math. Soc. Janos Bolyai, Vol.37. North-Holland, Amsterdam, 1984.
- [42] E. Szemerédi, *On sets of integers containing no k elements in arithmetic progression*. Acta Arithmetica 27, 1975.
- [43] J. V. Uspensky, *On a problem arising out of the theory of a certain game*. American Mathematical Monthly 34, 1927.
- [44] B. L. Van der Waerden, *Beweis einer Baudetschen Vermutung*, Nieuw Archief voor Wiskunde 15, 1927.
- [45] E. Zermelo, *Über eine Anwendung der Mengenlehre und der Theorie des Schachspiels*, in: *Proceedings of the Fifth International Congress of Mathematicians*, Cambridge, 1912.

Vita

Sujith Vijay

- 2002** M.Tech in Mathematics and Computing, Indian Institute of Technology, Delhi.
- 2007** Ph.D. in Mathematics, Rutgers, The State University of New Jersey

Publications

- 2003** A note on a theorem of Erdős and Gallai (with Amitabha Tripathi), *Discrete Mathematics* 263
- 2006** Dreidel lasts $O(n^2)$ spins (with Thomas Robinson), *Advances in Applied Mathematics* 36
- 2006** On the largest k -primitive subset of $[1, n]$, *Integers* 6